













**PETER'S
COOLING**

EQUIPMENT CATALOG

WWW.PETERSCOOLING.COM

 Peters Cooling

Whatsapp / Telefon +971 58 585 6901

	pages	
Vertical display coolers	1 - 28	
Display freezers	29 - 41	
Wine coolers	43 - 45	
Horizontal coolers and freezers	47 - 62	
Island coolers and freezers	63 - 68	
Glass cabinets	69 - 78	
Serve over counters	79 - 86	
Supermarket coolers and freezers	87 - 102	
Cold and freezer rooms	103 - 106	
Hospitality industry equipments	107 - 122	
Supermarket shelves	123 - 128	

VERTICAL DISPLAY COOLERS

ON OUR WEBSITE: WWW.PETERSCOOLING.COM

DISPLAY COOLER - CAN COOLER WITH GLASS LID WITH INTERNAL COOLING UNIT



FS45-BOTTLE



FS45-BOTTLE

Dimensions

FS45BOOTLE: Exterior 457 x 457 x 830 mm, Interior 375 x 375 x 470 mm

FS55BOOTLE: Exterior 457 x 457 x 1076 mm, Interior 380 x 380 x 655 mm



Specifications

Temperature Range : +2 / +12 C

Ambient Temperature: +16 / +35 C

Cooling: Ventilated

Mechanic Controller

Automatic Defrost

Steel Interior

Double Flip-Flop Lid

Wire Structure Included

Baskets Included

4 Castors, 1 Lockable

Volume:

FS45BOOTLE: 53 liters

FS55BOOTLE: 80 liters



DISPLAY COOLER WITH ONE DOOR AND BACKLIT CANOPY

WITH INTERNAL COOLING UNIT AND HINGED DOOR



FS425C CANOPY

Dimensions

Exterior	595 x 640 x 1980 mm
Interior	470 x 440 x 1555 mm



Specifications

- Temperature Range : +2 / +10 C
- Ambient Temperature: +16 / +25 C
- Cooling: Ventilated
- Doors With Double Glass
- Volume: 372 liters
- White LED Lighting
- 2 LED Strips (left and right)
- Mechanic Controller
- Automatic Defrost
- Digital Thermometer
- ABS Interior
- Hinged Door
- Shelves Included
- Adjustable Feet
- Lock Included

DISPLAY COOLER WITH ONE DOOR WITH INTERNAL COOLING UNIT AND HINGED DOOR



FS425C

Dimensions

Exterior	595 x 640 x 1840 mm
Interior	470 x 440 x 1555 mm



Specifications

Temperature Range : +2/ +10 C
Ambient Temperature: +16/ +25 C
Cooling: Ventilated
Doors With Double Glass
Volume: 372 liters
White LED Lighting
2 LED Strips (left and right)
Mechanic Controller
Automatic Defrost
Digital Thermometer
ABS Interior
Hinged Door
Shelves Included
Adjustable Feet
Lock Included

DISPLAY COOLER WITH ONE DOOR WITH INTERNAL COOLING UNIT AND HINGED DOOR



FS122C

Dimensions

Exterior	595 x 640 x 1315 mm
Interior	470 x 440 x 1027 mm



Specifications

- Temperature Range : +2/ +10 C
- Ambient Temperature: +16/ +25 C
- Cooling: Ventilated
- Doors With Double Glass
- Volume: 215 liters
- White LED Lighting
- 4 Castors
- Mechanical Controller
- Automatic Defrost
- Digital Thermometer
- ABS Interior
- Hinged Door
- Shelves Included
- Adjustable Feet
- Lock Included

DISPLAY COOLER WITH ONE DOOR AND BACKLIT CANOPY WITH INTERNAL COOLING UNIT AND HINGED DOOR



FS1450C

Dimensions

Exterior	680 x 655 x 2090 mm
Interior	585 x 495 x 1515 mm



Specifications

- Temperature Range : +2/ +10 C
- Ambient Temperature: +16/ +25 C
- Cooling: Ventilated
- Doors With Double Glass
- Volume: 438 liters
- White LED Lighting
- 2 Castors
- Mechanical Controller
- Automatic Defrost
- Digital Thermometer
- ABS Interior
- Hinged Door
- Shelves Included
- Adjustable Feet
- Lock Included

DISPLAY COOLER WITH TWO COOLING ZONES WITH INTERNAL COOLING UNIT AND HINGED DOORS

VERTICAL DISPLAY COOLERS



FS2375C

Dimensions

Exterior	595 x 640 x 1840 mm
Interior	470 x 440 x 1555 mm



Specifications

- Temperature Range : +2 / +10 C
- Ambient Temperature: +16 / +25 C
- Cooling: Ventilated
- Doors With Double Glass
- Volume: 372 liters
- White LED Lighting
- 2 Castors
- Mechanical Controller
- Automatic Defrost
- Digital Thermometer
- ABS Interior
- Hinged Doors
- Shelves Included
- Adjustable Feet
- Lock Included

SLIM DISPLAY COOLER WITH ONE DOOR AND BACKLIT CANOPY WITH INTERNAL COOLING UNIT AND HINGED DOOR



FS175C SLIM

Dimensions

Exterior	435 x 505 x 2013 mm
Interior	357 x 362 x 1410 mm



Specifications

- Temperature Range : +2 / +10 C
- Ambient Temperature: +16 / +25 C
- Cooling: Ventilated
- Doors With Double Glass
- Volume: 182 liters
- White LED Lighting
- 2 LED Strips (left and right)
- 2 Castors
- Mechanical Controller
- Automatic Defrost
- Digital Thermometer
- ABS Interior
- Hinged Door
- Shelves Included
- Adjustable Feet
- Lock Included

BACKBAR COOLER WITH SLIDING OR HINGED DOORS

VITRINE FRIGORIFICE
- VERTICALE



2 doors : Exterior 1462 x 513 x 860 mm

3 doors: Exterior 2002 x 513 x 860 mm

4 doors: Exterior 2542 x 513 x 860 mm

2 doors: Exterior 1462 x 513 x 860 mm

3 doors: Exterior 2002 x 513 x 860 mm

4 doors: Exterior 2542 x 513 x 860 mm

1 door: Exterior 500 x 520 x 870 mm

1 door: Exterior 500 x 520 x 900 mm

2 doors: Exterior 900 x 520 x 870 mm

3 doors: Exterior 1350 x 520 x 870mm

FS BAR



Specifications

Temperature Range : +2 / +10 C

Ambient Temperature: +16 / +35 C

Cooling: Ventilated

Low Electric Consumption

White LED Lighting

Digital Controller Dixell XR06CX

Automatic Defrost

Aluminium or Stainless Steel Interior

Hinged Or Sliding Doors

Shelves Included

Adjustable Feet

Lock Included

Stainless Steel Exterior as an Option

DISPLAY COOLER WITH ONE DOOR AND BACKLIT CANOPY

WITH INTERNAL COOLING UNIT AND HINGED DOOR

VERTICAL DISPLAY COOLERS



FS2500C

Dimensions

Exterior	680 x 700 x 2022 mm
Interior	560 x 580 x 1327 mm



Specifications

- Temperature Range : +2/ +8 C
- Ambient Temperature: +16/ +25 C
- Cooling: Ventilated
- Doors With Double Glass
- Volume: 515 liters
- 4 Castors
- White LED Lighting
- 2 LED Strips (left and right)
- Digital Controller
- Automatic Defrost
- Digital Thermometer
- Steel Interior - Painted
- Hinged Door
- Shelves Included
- Adjustable Feet
- Lock Included

DISPLAY COOLER WITH TWO DOORS AND BACKLIT CANOPY

WITH INTERNAL COOLING UNIT AND HINGED DOORS



FS1200C CANOPY

Dimensions

Exterior	1200 x 790 x 2000 mm
Interior	1090 x 670 x 1533 mm



Specifications

- Temperature Range : +2/ +8 C
- Ambient Temperature: +16/ +25 C
- Cooling: Ventilated
- Doors With Double Glass
- Volume: 1082 liters
- 4 Castors
- White LED Lighting
- 2 LED Strips (left and right)
- Digital Controller
- Automatic Defrost
- Digital Thermometer
- ABS Interior
- Hinged Doors
- Shelves Included
- Adjustable Feet
- Lock Included

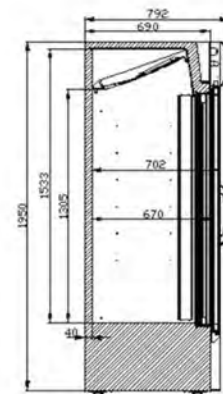
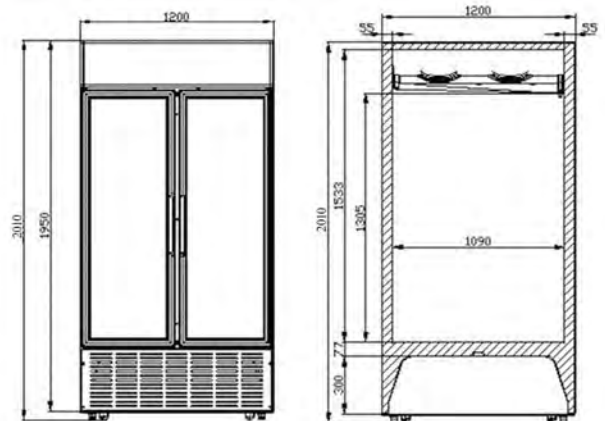

DISPLAY COOLER WITH TWO DOORS WITH INTERNAL COOLING UNIT AND HINGED DOORS

VERTICAL DISPLAY COOLERS



FS1210C

Dimensions

Exterior	1200 x 735 x 1990 mm
Interior	1090 x 573 x 1533 mm



Specifications

- Temperature Range : +2 / +8 C
- Ambient Temperature: +16 / +25 C
- Cooling: Ventilated
- Doors With Double Glass
- Volume: 936 liters
- 4 Castors
- White LED Lighting
- 2 LED Strips (left and right)
- Digital Controller
- Automatic Defrost
- Digital Thermometer
- Steel Interior - Painted
- Hinged Doors
- Shelves Included
- Adjustable Feet
- Lock Included

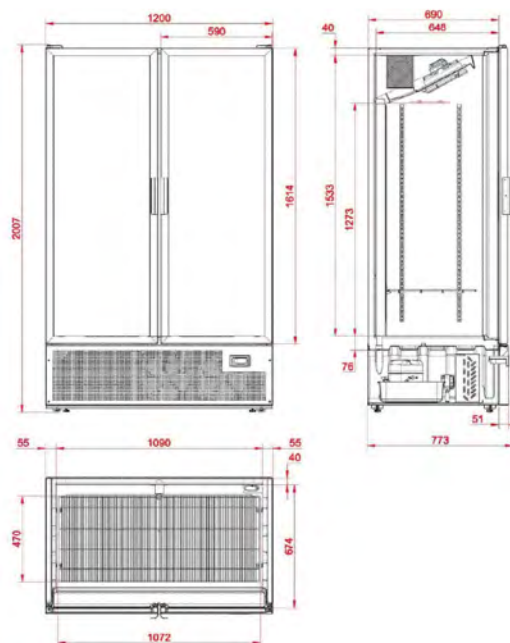

DISPLAY COOLER WITH THREE DOORS WITH INTERNAL COOLING UNIT AND HINGED DOORS

VERTICAL DISPLAY COOLERS



FS1600C

Dimensions

Exterior	1600 x 730 x 2073 mm
Interior	1492 x 585 x 1518 mm



Specifications

- Temperature Range : +2/ +8 C
- Ambient Temperature: +16/ +25 C
- Cooling: Ventilated
- Doors With Double Glass
- Volume: 1329 liters
- 6 Castors
- White LED Lighting
- 2 LED Strips (left and right)
- Digital Controller
- Automatic Defrost
- Digital Thermometer
- Steel Interior - Painted
- Hinged Doors
- Shelves Included
- Adjustable Feet
- Lock Included

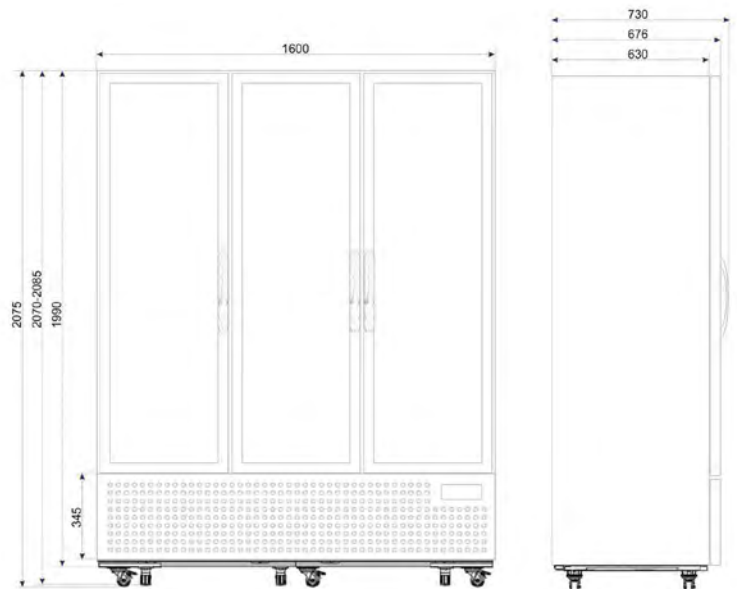

DISPLAY COOLER WITH THREE DOORS AND BACKLIT CANOPY WITH INTERNAL COOLING UNIT AND HINGED DOORS

VERTICAL DISPLAY COOLERS



FS1600C CANOPY

Dimensions

Exterior	1600 x 730 x 2073 mm
Interior	1492 x 585 x 1518 mm



Specifications

- Temperature Range : +2 / +8 C
- Ambient Temperature: +16 / +25 C
- Cooling: Ventilated
- Doors With Double Glass
- Volume: 1329 liters
- 6 Castors
- White LED Lighting
- 2 LED Strips (left and right)
- Digital Controller
- Automatic Defrost
- Digital Thermometer
- Steel Interior - Painted
- Hinged Doors
- Shelves Included
- Adjustable Feet
- Lock Included

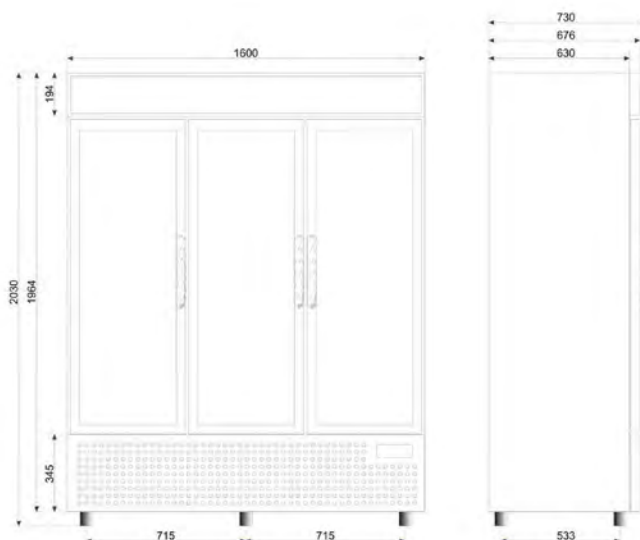

DISPLAY COOLER WITH TWO DOORS AND BACKLIT CANOPY WITH INTERNAL COOLING UNIT AND HINGED DOORS



FS100HC



Dimensions

Exterior	1000 x 790 x 2000 mm
Interior	890 x 670 x 1533 mm



Specifications

- Temperature Range : +2 / +8 C
- Ambient Temperature: +16 / +25 C
- Cooling: Ventilated
- Doors With Double Glass
- Volume: 796 liters
- 4 Castors
- White LED Lighting
- 2 LED Strips (left and right)
- Digital Controller
- Automatic Defrost
- Digital Thermometer
- Steel Interior - Painted
- Hinged Doors
- Shelves Included
- Adjustable Feet
- Lock Included

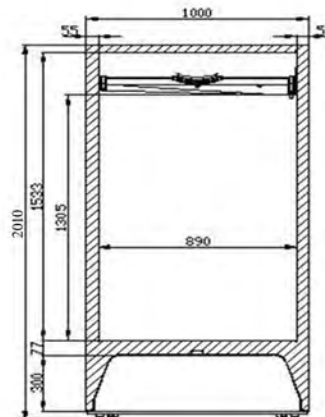
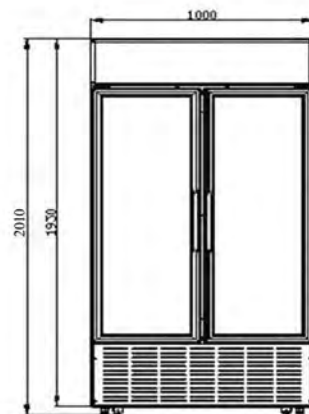

DISPLAY COOLER WITH TWO DOORS AND BACKLIT CANOPY

WITH INTERNAL COOLING UNIT AND SLIDING DOORS



FS100 SLIDING CANOPY

Dimensions

Exterior	1000 x 735 x 1990 mm
Interior	890 x 573 x 1533 mm



Specifications

- Temperature Range : +2/ +8 C
- Ambient Temperature: +16/ +25 C
- Cooling: Ventilated
- Doors With Double Glass
- Volume: 771 liters
- 4 Castors
- White LED Lighting
- 2 LED Strips (left and right)
- Digital Controller
- Automatic Defrost
- Digital Thermometer
- Steel Interior - Painted
- Sliding Doors
- Shelves Included
- Adjustable Feet
- Lock Included

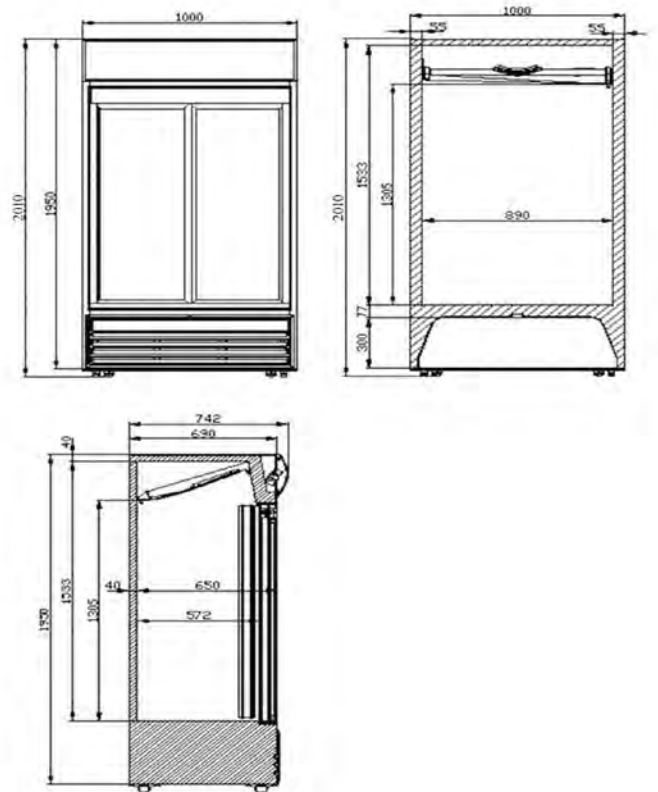

DISPLAY COOLER WITH TWO DOORS WITH INTERNAL COOLING UNIT AND SLIDING DOORS



VERTICAL DISPLAY COOLERS

FS100 SLIDING

Dimensions

Exterior	1000 x 735 x 1990 mm
Interior	890 x 573 x 1533 mm



Specifications

- Temperature Range : +2/ +8 C
- Ambient Temperature: +16/ +25 C
- Cooling: Ventilated
- Doors With Double Glass
- Volume: 730 liters
- 4 Castors
- White LED Lighting
- 2 LED Strips (left and right)
- Digital Controller
- Automatic Defrost
- Digital Thermometer
- Steel Interior - Painted
- Sliding Doors
- Shelves Included
- Adjustable Feet
- Lock Included

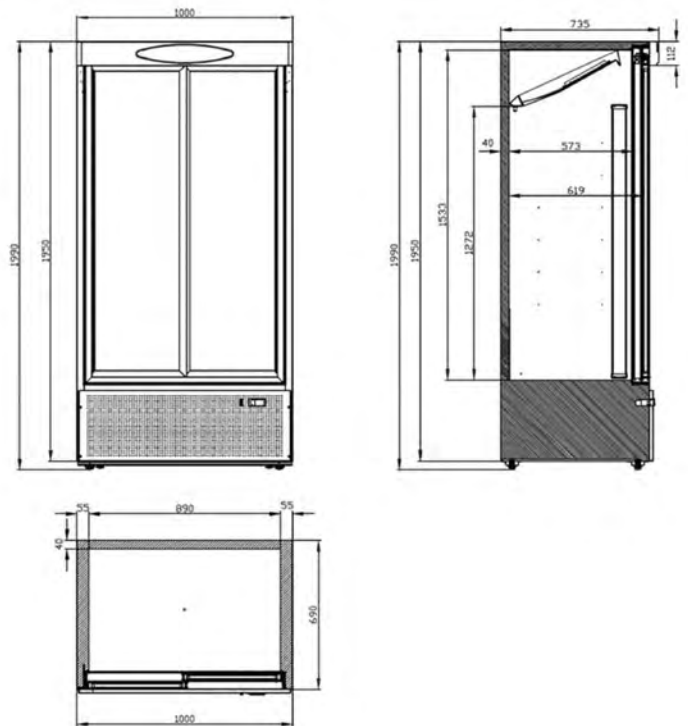

DISPLAY COOLER WITH TWO DOORS WITH INTERNAL COOLING UNIT AND SLIDING DOORS

VERTICAL DISPLAY COOLERS



FS120 SLIDING

Dimensions

Exterior	1200 x 735 x 1990 mm
Interior	1090 x 573 x 1533 mm



Specifications

- Temperature Range : +2 / +8 C
- Ambient Temperature: +16 / +25 C
- Cooling: Ventilated
- Doors With Double Glass
- Volume: 895 liters
- 4 Castors
- White LED Lighting
- 2 LED Strips (left and right)
- Digital Controller
- Automtatic Defrost
- Digital Thermometer
- Steel Interior - Painted
- Sliding Doors
- Shelves Included
- Adjustable Feet
- Lock Included

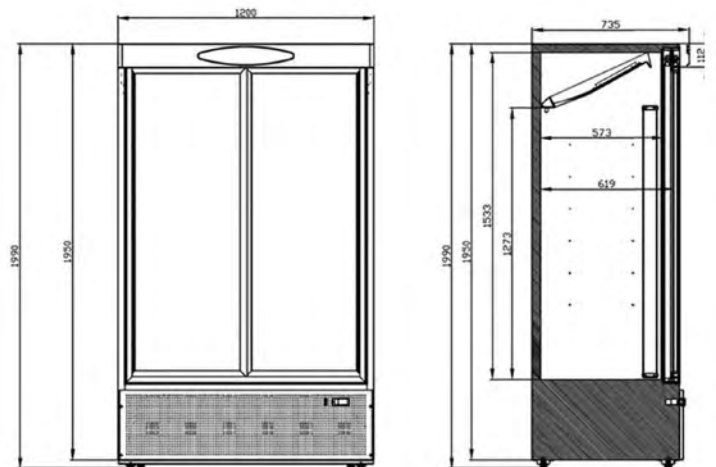

DISPLAY COOLER WITH TWO DOORS AND BACKLIT CANOPY

WITH INTERNAL COOLING UNIT AND HINGED DOORS



FS120 SLIDING CANOPY

Dimensions

Exterior	1200 x 790 x 2000 mm
Interior	1090 x 670 x 1533 mm



Specifications

- Temperature Range : +2 / +8 C
- Ambient Temperature: +16 / +25 C
- Cooling: Ventilated
- Doors With Double Glass
- Volume: 1082 liters
- 4 Castors
- White LED Lighting
- 2 LED Strips (left and right)
- Digital Controller
- Automatic Defrost
- Digital Thermometer
- Steel Interior - Painted
- Hinged Doors
- Shelves Included
- Adjustable Feet
- Lock Included

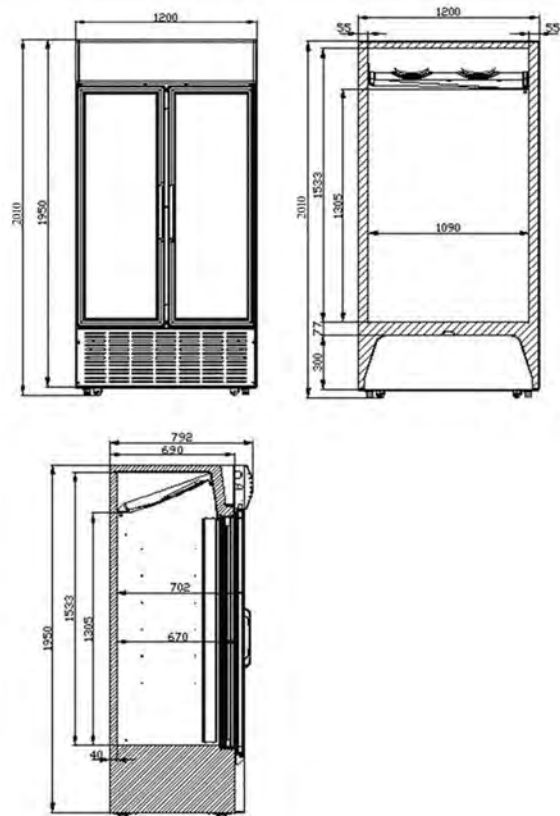

DISPLAY COOLER WITH TWO DOORS WITH INTERNAL COOLING UNIT AND HINGED DOORS



FS890C

Dimensions

Exterior	890 x 740 x 1990 mm
Interior	810 x 561 x 1556 mm



Specifications

- Temperature Range : +2/ +8 C
- Ambient Temperature: +16/ +25 C
- Cooling: Ventilated
- Doors With Double Glass
- Volume: 707 liters
- 4 Castors
- White LED Lighting
- 2 LED Strips (left and right)
- Digital Controller
- Automatic Defrost
- Digital Thermometer
- Steel Interior - Painted
- Hinged Doors
- Shelves Included
- Adjustable Feet
- Lock Included

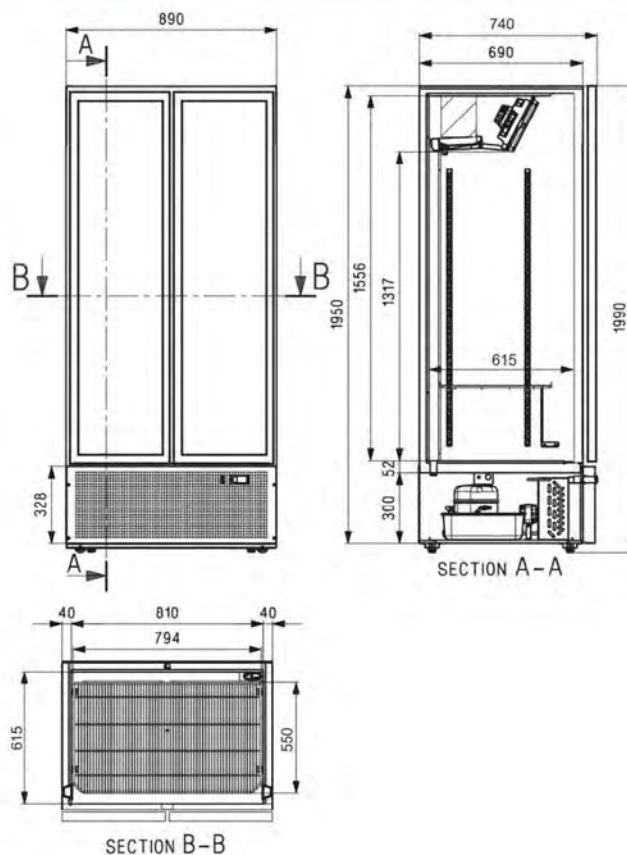

DISPLAY COOLER WITH TWO DOORS AND BACKLIT CANOPY

WITH INTERNAL COOLING UNIT AND HINGED DOORS



FS890HC CANOPY

Dimensions

Exterior	890 x 740 x 1990 mm
Interior	810 x 561 x 1556 mm



Specifications

- Temperature Range : +2 / +8 C
- Ambient Temperature: +16 / +25 C
- Cooling: Ventilated
- Doors With Double Glass
- Volume: 707 liters
- 4 Castors
- White LED Lighting
- 2 LED Strips (left and right)
- Digital Controller
- Automatic Defrost
- Digital Thermometer
- Steel Interior - Painted
- Hinged Doors
- Shelves Included
- Adjustable Feet
- Lock Included

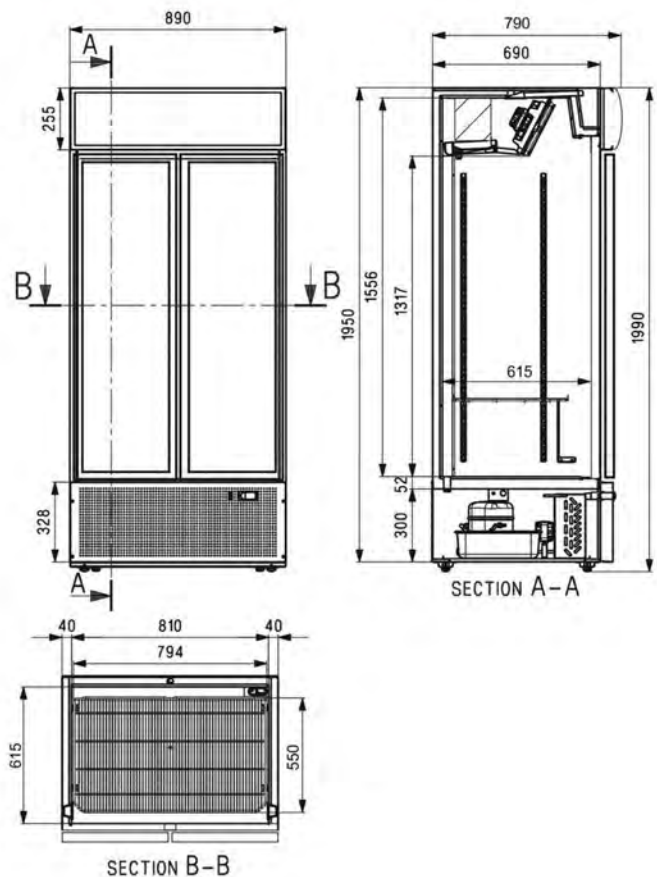

DISPLAY COOLER WITH ONE DOOR AND BACKLIT CANOPY

WITH INTERNAL COOLING UNIT AND HINGED DOOR



FS2500C CANOPY

Dimensions

Exterior	680 x 700 x 2022 mm
Interior	560 x 580 x 1327 mm



Specifications

- Temperature Range : +2 / +8 C
- Ambient Temperature: +16 / +25 C
- Cooling: Ventilated
- Doors With Double Glass
- Volume: 515 liters
- 4 Castors
- White LED Lighting
- 2 LED Strips (left and right)
- Digital Controller
- Automatic Defrost
- Digital Thermometer
- Steel Interior - Painted
- Hinged Door
- Shelves Included
- Adjustable Feet
- Lock Included

DISPLAY COOLER WITH TWO DOORS AND BACKLIT CANOPY WITH INTERNAL COOLING UNIT AND HINGED DOORS

VERTICAL DISPLAY COOLERS



FS1370C



Dimensions

Exterior	1370 x 700 x 2022 mm
Interior	1250 x 580 x 1327 mm



Specifications

- Temperature Range : +2 / +8 C
- Ambient Temperature: +16 / +25 C
- Cooling: Ventilated
- Doors With Double Glass
- Volume: 1149 liters
- 4 Castors
- White LED Lighting
- 2 LED Strips (left and right)
- Digital Controller
- Automatic Defrost
- Digital Thermometer
- Steel Interior - Painted
- Hinged Doors
- Shelves Included
- Adjustable Feet
- Lock Included

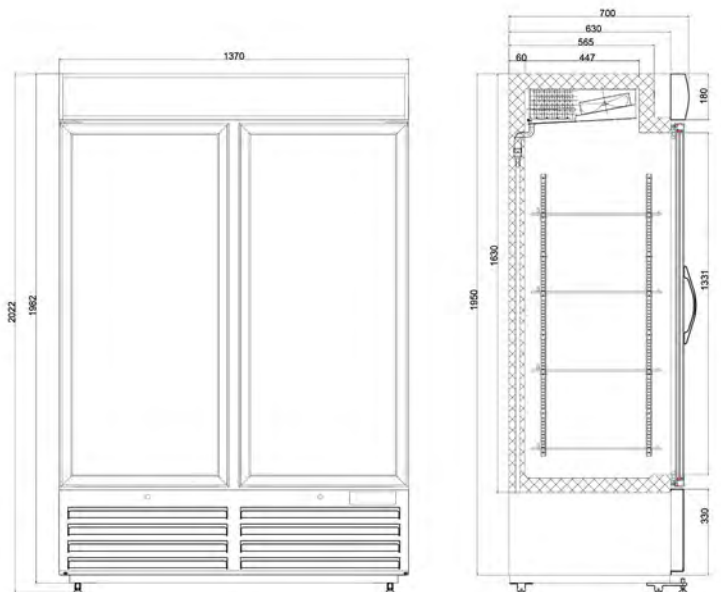

DISPLAY COOLER WITH THREE DOORS AND BACKLIT CANOPY WITH INTERNAL COOLING UNIT AND HINGED DOORS



FS2005C

Dimensions

Exterior	2057 x 700 x 2022 mm
Interior	1937 x 580 x 1327 mm



Specifications

- Temperature Range : +2 / +8 C
- Ambient Temperature: +16 / +25 C
- Cooling: Ventilated
- Doors With Double Glass
- Volume: 1784 liters
- 6 Castors
- White LED Lighting
- 2 LED Strips (left and right)
- Digital Controller
- Automatic Defrost
- Digital Thermometer
- Steel Interior - Painted
- Hinged Doors
- Shelves Included
- Adjustable Feet
- Lock Included

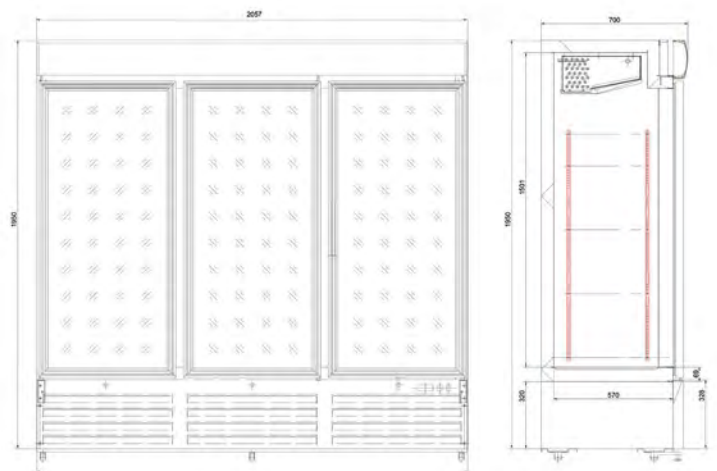

DISPLAY COOLER WITH ONE DOOR WITH INTERNAL COOLING UNIT AND HINGED DOOR



ATOM MAXI C1 ECO

Dimensions

Exterior	750 x 710 x 2003 mm
Interior	660 x 595 x 1568 mm



Specifications

Temperature Range : -1 / +10 C
Ambient Temperature: +16 / +26 C
Volume: 614 liters
Equipped With Digital Thermostat
Input Power: 460 W
Voltage: 220-240/50
White LED Lighting 38 W
Energy Consumption: 2.5kWh / 24h
Power Cable Length: 1750 mm
Refrigerant: R290
Noise Level: 49.6 dB (very silent)
Castors
Self-closing Hinged Glass Doors
5 Adjustable Shelves Per Compartment
2 LED Strips (left and right) Each Door
Freezer Version as an Option
NET Weight: 141 kg

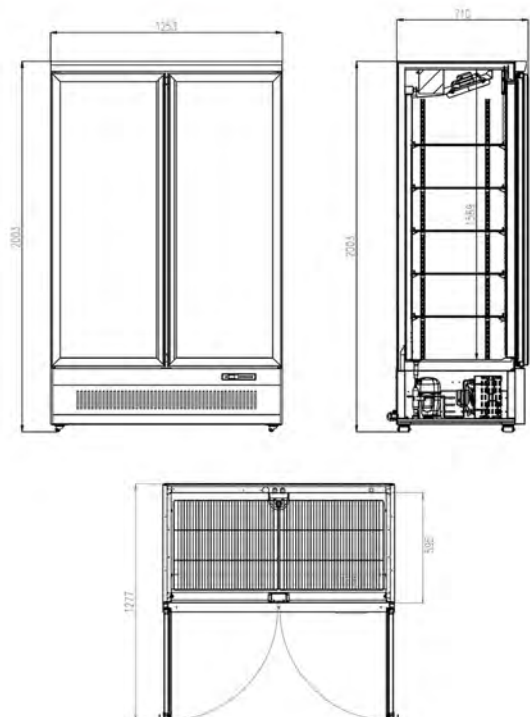

DISPLAY COOLER WITH TWO DOORS WITH INTERNAL COOLING UNIT AND HINGED DOORS



ATOM MAXI C2 ECO

Dimensions

Exterior	1253 x 710 x 2003 mm
Interior	1163 x 595 x 1568 mm



Specifications

Temperature Range : -1 / +10 C
Ambient Temperature: +16 / +26 C
Volume: 1080 liters
Equipped With Digital Thermostat
Input Power: 465 W
Voltage: 220-240/50
White LED Lighting 38 W
Energy Consumption: 4.17kWh / 24h
Power Cable Length: 1750 mm
Refrigerant: R290
Noise Level: 49.6 dB (very silent)
Castors
Self-closing Hinged Glass Doors
5 Adjustable Shelves Per Compartment
2 LED Strips (left and right) Each Door
Freezer Version as an Option
NET Weight: 197 kg

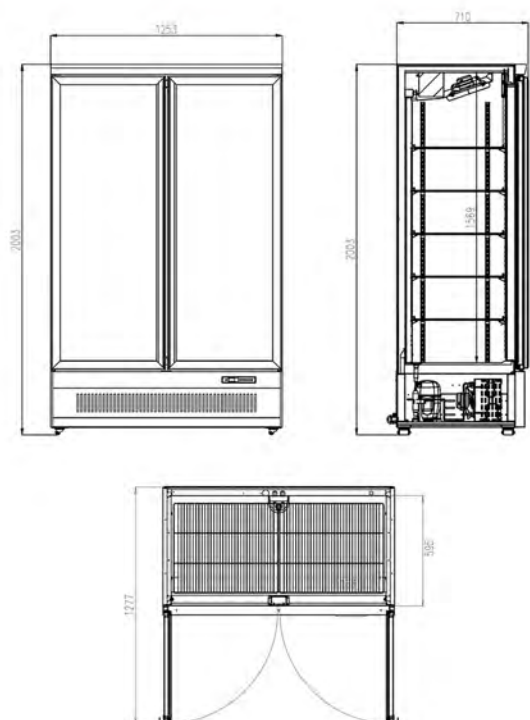

DISPLAY COOLER WITH THREE DOORS WITH INTERNAL COOLING UNIT AND HINGED DOORS



ATOM MAXI C3 ECO

Dimensions

Exterior 1880 x 710 x 2003 mm
Interior 1790 x 600 x 1570 mm



Specifications

Temperature Range : -1 / +10 C
Ambient Temperature: +16 / +26 C
Volume: 1664 liters
Cooling: Ventilated
Equipped With Digital Thermostat
Input Power: 700 W
Voltage: 220-240/50
White LED Lighting 38 W
Energy Consumption: 5.41kWh / 24h
Power Cable Length: 1750 mm
Refrigerant: R290
Noise Level: 49.6 dB (very silent)
Castors
Self-closing Hinged Glass Doors
5 Adjustable Shelves Per Compartment
2 LED Strips (left and right) Each Door
Freezer Version as an Option
NET Weight: 235 kg

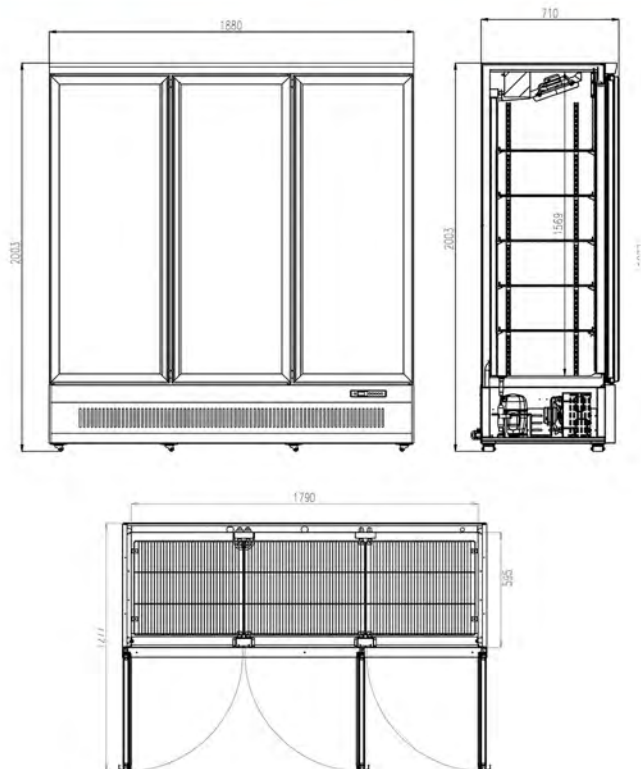

DISPLAY COOLER WITH FOUR DOORS WITH INTERNAL COOLING UNIT AND HINGED DOORS



ATOM MAXI C4 ECO

Dimensions

Exterior	2500 x 710 x 2003 mm
Interior	2390 x 590 x 1570 mm



Specifications

Temperature Range : -1 / +10 C
Ambient Temperature: +16 / +26 C
Volume: 2210 liters
Cooling: Ventilated
Equipped With Digital Thermostat
Input Power: 1000 W
Voltage: 220-240/50
White LED Lighting 38 W
Energy Consumption: 8.41 kWh / 24h
Power Cable Length: 1750 mm
Refrigerant: R290
Noise Level: 49.6 dB (very silent)
Castors
Self-closing Hinged Glass Doors
5 Adjustable Shelves Per Compartment
2 LED Strips (left and right) Each Door
Freezer Version as an Option
NET Weight: 280 kg

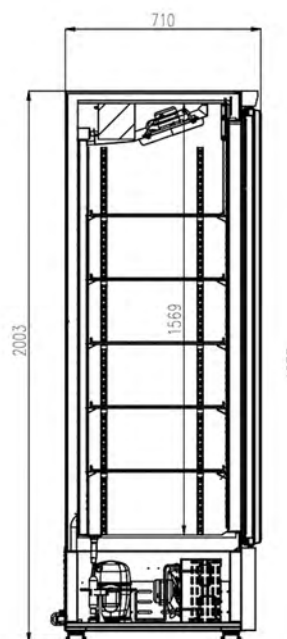

DISPLAY FREEZERS

ON OUR WEBSITE: WWW.PETERSCOOLING.COM

DISPLAY FREEZER WITH ONE HINGED DOOR WITH INTERNAL COOLING UNIT

DISPLAY FREEZERS



FS200F

Dimensions

Exterior	600 x 585 x 855 mm
Interior	484 x 470 x 620 mm



Specifications

- Temperature Range : -10 / -24 C
- Ambient Temperature: +16 / +25 C
- Cooling: Ventilated
- Doors With Double Glass
- Volume: 200 liters
- 2 Castors
- White LED Lighting
- Heated Anti-Fog Glass Door
- Digital Controller
- Automatic Defrost
- Digital Thermometer
- Steel Interior - Painted
- Hinged Door
- Shelves Included
- Adjustable Feet
- Lock Included

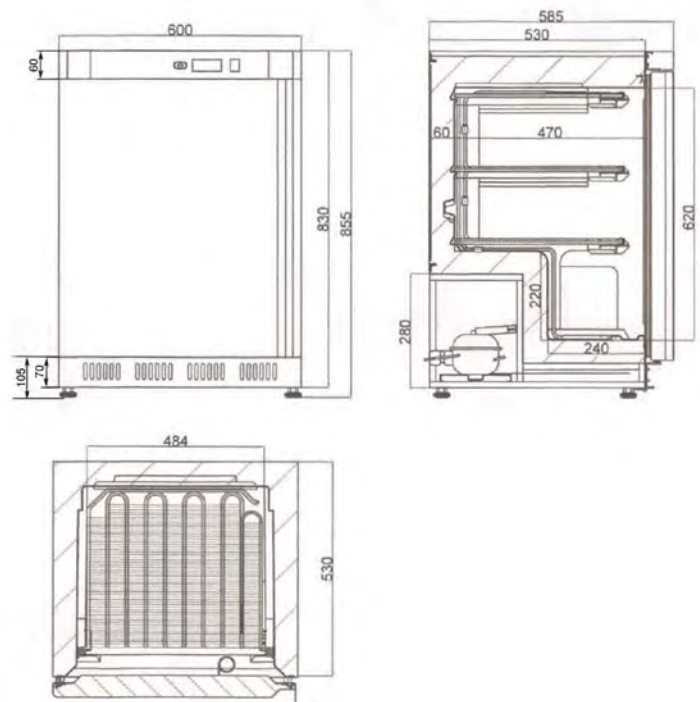

DISPLAY FREEZER WITH ONE HINGED DOOR WITH INTERNAL COOLING UNIT

DISPLAY FREEZERS



FS370F



Dimensions

Exterior	595 x 640 x 1980 mm
Interior	470 x 440 x 1555 mm



Specifications

- Temperature Range : -14 / -24 C
- Ambient Temperature: +16 / +25 C
- Cooling: Static
- Doors With Double Glass
- Volume: 300 liters
- 2 Castors
- White LED Lighting
- Heated Anti-Fog Glass Door
- Digital Controller
- Manual Defrost
- Digital Thermometer
- Hinged Door
- Shelves Included
- Adjustable Feet
- Lock Included

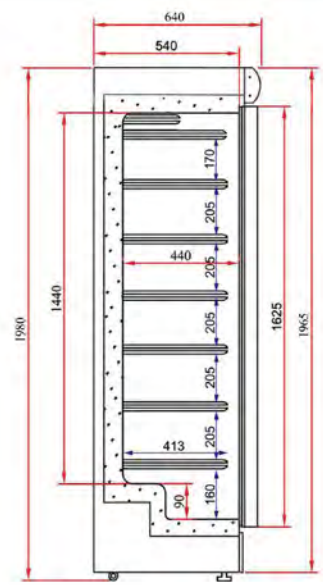
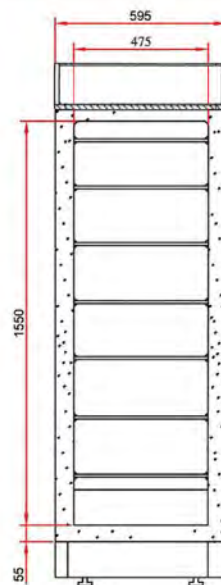

DISPLAY FREEZER WITH ONE HINGED DOOR WITH INTERNAL COOLING UNIT

DISPLAY FREEZERS



FS400F

Dimensions

Exterior	600 x 600 x 1850 mm
Interior	484 x 470 x 1620 mm



Specifications

Temperature Range : -10 / -24 C
Ambient Temperature: +16 / +25 C
Cooling: Ventilated
Doors With Double Glass
Volume: 400 liters
2 Castors
White LED Lighting
Heated Anti-Fog Glass Door
Stainless Steel Exterior
Digital Controller
Automatic Defrost
Digital Thermometer
Steel Interior - Painted
Hinged Door
Shelves Included
Adjustable Feet
Lock Included

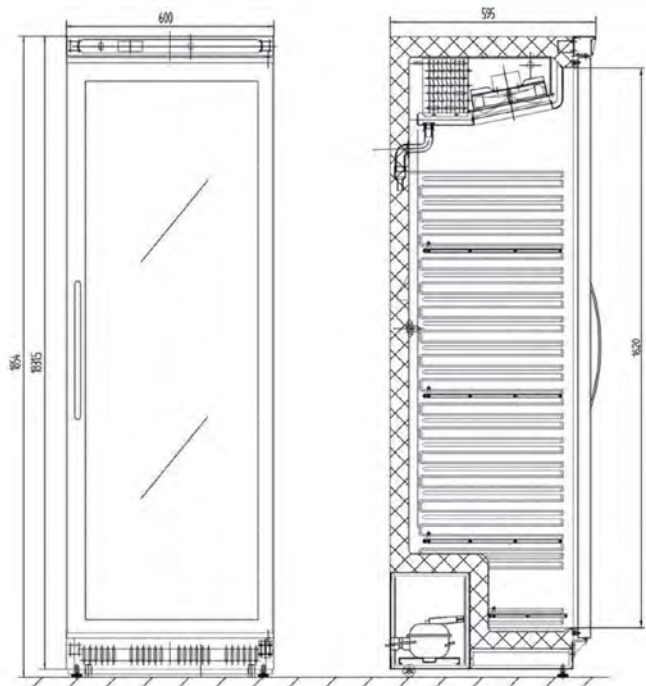

DISPLAY FREEZER WITH ONE HINGED DOOR WITH INTERNAL COOLING UNIT

DISPLAY FREEZERS



ATOM MAXI FI ECO

Dimensions

Exterior	750 x 710 x 2003 mm
Interior	663 x 580 x 1540 mm



Specifications

Temperature Range :	-18 / -22 C
Ambient Temperature:	+16 / +26 C
Volume:	1080 liters
Cooling:	Ventilated
Equipped With	Digital Thermostat
Input Power:	600 W
Voltage:	220-240/50
White LED Lighting	38 W
Energy Consumption:	9.07 kWh / 24h
Power Cable Length:	1750 mm
Refrigerant:	R290
Noise Level:	49.6 dB (very silent)
Castors	
Self-closing Hinged Glass Doors	
5 Adjustable Shelves Per Compartment	
2 LED Strips (left and right) Each Door	
Cooler Version as an Option	
NET Weight:	160 kg

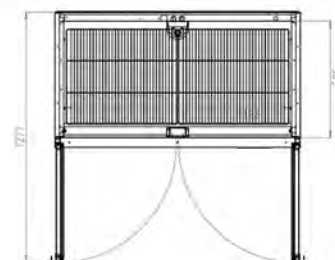
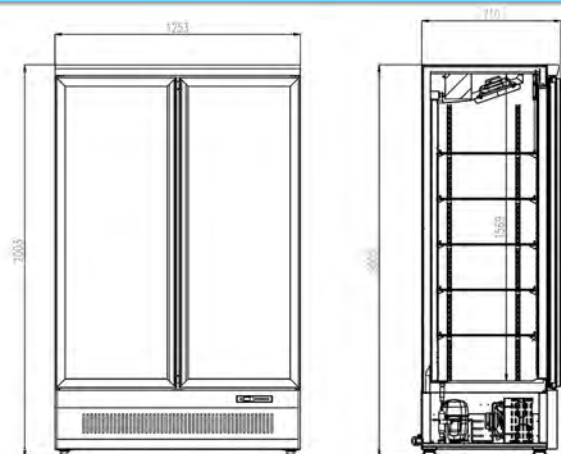

DISPLAY FREEZER WITH TWO HINGED DOORS WITH INTERNAL COOLING UNIT

DISPLAY FREEZERS



ATOM MAXI F2 ECO

Dimensions

Exterior	600 x 600 x 1850 mm
Interior	484 x 470 x 1620 mm



Specifications

Temperature Range :	-18 / -22 C
Ambient Temperature:	+16 / +26 C
Volume:	1080 liters
Cooling:	Ventilated
Equipped With	Digital Thermostat
Input Power:	1205 W
Voltage:	220-240/50
White LED Lighting	38 W
Energy Consumption:	17.47 kWh / 24h
Power Cable Length:	1750 mm
Refrigerant:	R290
Noise Level:	49.6 dB (very silent)
Castors	
Self-closing Hinged Glass Doors	
5 Adjustable Shelves Per Compartment	
2 LED Strips (left and right) Each Door	
Cooler Version as an Option	
NET Weight:	270 kg

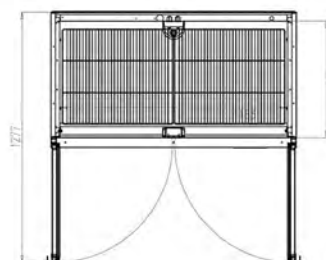
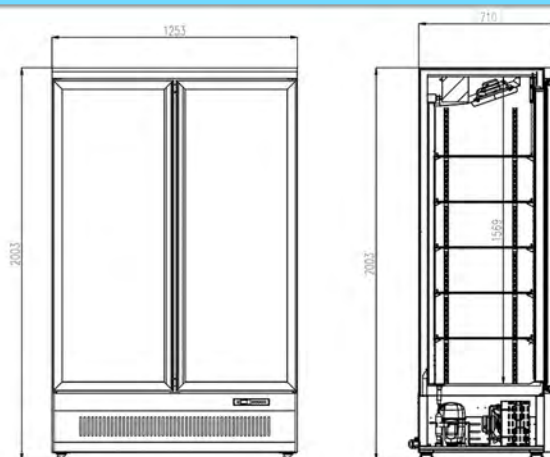

DISPLAY FREEZER WITH THREE HINGED DOORS WITH INTERNAL COOLING UNIT

DISPLAY FREEZERS



ATOM MAXI F3 ECO

Dimensions

Exterior	1880 x 710 x 2003 mm
Interior	1790 x 595 x 1568 mm



Specifications

- Temperature Range : -18 / -22 C
- Ambient Temperature: +16 / +26 C
- Volume: 1563 liters
- Cooling: Ventilated
- Equipped With Digital Thermostat
- Input Power: 1280 W
- Voltage: 220-240/50
- White LED Lighting 38 W
- Energy Consumption: 23.84 kWh / 24h
- Power Cable Length: 1750 mm
- Refrigerant: R290
- Noise Level: 49.6 dB (very silent)
- Castors
- Self-closing Hinged Glass Doors
- 5 Adjustable Shelves Per Compartment
- 2 LED Strips (left and right) Each Door
- Cooler Version Available
- NET Weight: 355 kg

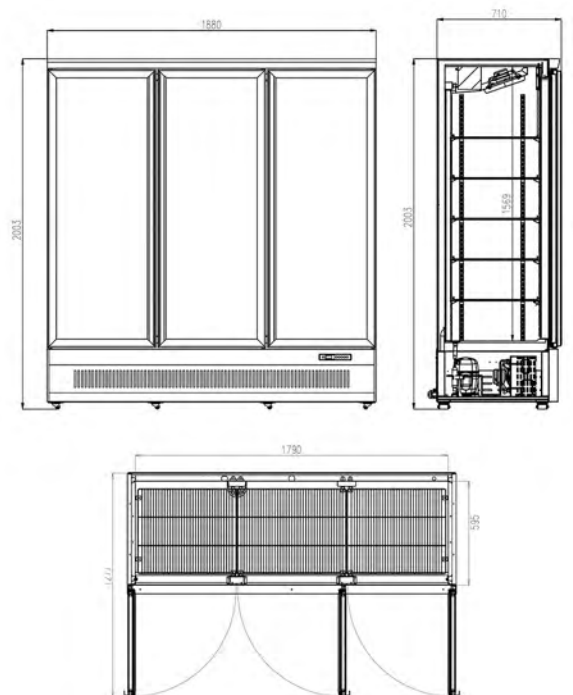

DISPLAY FREEZER WITH FOUR HINGED DOORS WITH INTERNAL COOLING UNIT

DISPLAY FREEZERS



ATOM MAXI F4 ECO

Dimensions

Exterior 2500 x 710 x 2003 mm
Interior 2370 x 580 x 1540 mm



Specifications

- Temperature Range : -18 / -22 C
- Ambient Temperature: +16 / +26 C
- Volume: 2210 liters
- Cooling: Ventilated
- Equipped With Digital Thermostat
- Input Power: 1700 W
- Voltage: 220-240/50
- White LED Lighting 38 W
- Energy Consumption: 28.62 kWh / 24h
- Power Cable Length: 1750 mm
- Refrigerant: R290
- Noise Level: 49.6 dB (very silent)
- Castors
- Self-closing Hinged Glass Doors
- 5 Adjustable Shelves Per Compartment
- 2 LED Strips (left and right) Each Door
- Cooler Version Available
- NET Weight: 280 kg

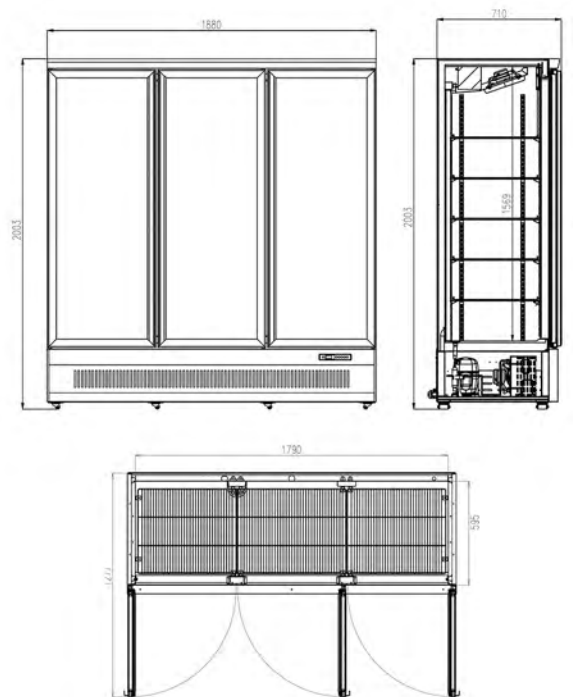

DISPLAY FREEZER WITH ONE, TWO OR THREE HINGED DOORS WITH INTERNAL COOLING UNIT



FS68F



FS137F



FS205F



DISPLAY FREEZERS

Dimensions

FS68F, 1 door: Exterior 680 x 720 x 2020 mm, Interior 560 x 580 x 1270 mm

FS137F, 2 doors: Exterior 1370 x 720 x 2020 mm, Interior 1250 x 570 x 1331 mm

FS205F, 3 doors: Exterior 2057 x 700 x 2020 mm, Interior 1937 x 580 x 1327 mm

Specifications

Temperature Range : -12 / -24 C

Ambient Temperature: +16 / +25 C

Cooling: Ventilated

Doors With Double Glass

2 Castors

White LED Lighting

2 LED Strips (left and right) Each Door

Heated Anti-Fog Glass Door

Digital Controller

Automatic Defrost

Digital Thermometer

Hinged Door

Shelves Included

Adjustable Feet

Lock Included

Volume:

FS68F: 515 liters

FS137F: 1149 liters

FS205F: 1784 liters

DISPLAY FREEZER FOR SUPERMARKET WITH INTERNAL COOLING UNIT

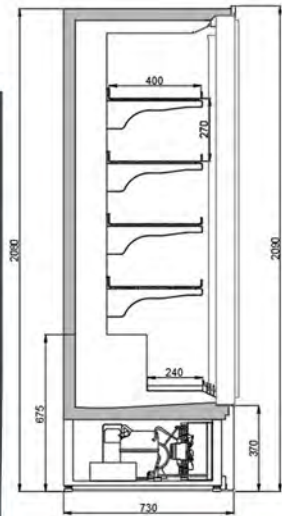

Dimensions

Length (mm) 1350 2000 2600

*or any dimension with multiplexing

PALERMO PREMIUM



Specifications

Temperature Range: -18 / -24 C

Cooling: Ventilated

Exterior depth 74 or 89 cm

Height: 205 cm or 220 cm as an OPTION

Color: Light Gray Interior, Antracit Gray Exterior (or any other color)

2x End Walls With Polyurethane Insulation And Anti Scratch Paint

Doors With Triple Glass And Anti-Fog System

Doors With Blocker For The Period Of Loading

ECO FREE BLACK Self-closing Glass Doors

White LED Lighting On Each Door For Perfect Visibility

LED 6500K Or 4500K

4 Shelves Of 40 Or 55 Cm On Each Row (plus base shelf)

Shelves With Front Riser and Ticket Strip

Professional Controller Dixell XR60CH

Electrical Resistance For Automatic Defrosting

Electrical Resistance For Condensation Water Evaporation

Electric Panel Included

Thermostatic Valve Included

Solenoid Valve Included

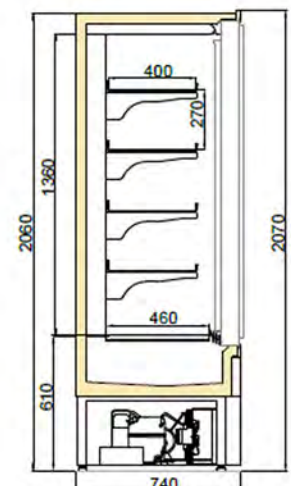
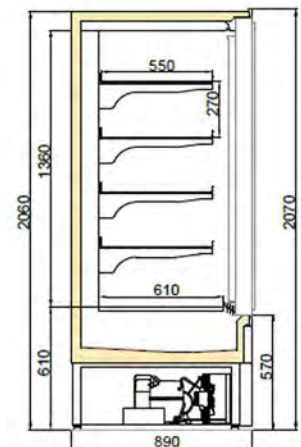

Optional

Extra Shelves As An Option

Plexiglass Separator Between Shelves As An Option

Electrical Resistance For Condensation Water Evaporation As An Opt.

DISPLAY FREEZER FOR SUPERMARKET WITH **INTERNAL** OR **EXTERNAL** COOLING UNIT



DISPLAY FREEZERS

Dimensions

Length (mm) 1564 2344 3124 3925
*or any dimension with multiplexing

AHT HMOP PREMIUM

Specifications

- Temperature Range: -18 / -24 C
- Cooling: Ventilated
- Exterior depth 90 or 100 cm
- Height: 205 cm or 220 cm as an OPTION
- Color: Light Gray Interior, Antracit Gray Exterior (or any other color)
- 2x Glass End Walls
- Doors With Triple Glass And Anti-Fog System
- Doors With Blocker For The Period Of Loading
- ECO FREE BLACK Self-closing Glass Doors
- White LED Lighting On Each Door For Perfect Visibility
- LED 6500K Or 4500K
- 5 Shelves Of 40 Or 55 Cm On Each Row (plus base shelf)
- Shelves with Front Riser and Ticket Strip
- Professional Controller Dixell XR60CH
- Electric Resistance For Automatic Defrosting
- Electric Resistance For Condensation Water Evaporation
- Electric Panel Included
- Thermostatic Valve Included
- Solenoid Valve Included

Optional

- Extra Shelves As An Option
- Plexiglass Separator Between Shelves as an Option
- Electric Resistance For Condensation Water Evaporation as an Option

DISPLAY FREEZER FOR SUPERMARKET WITH **EXTERNAL** COOLING UNIT

DISPLAY FREEZERS



Dimensions

Length (mm) 1650 2440 3220 4000

*or any dimension with multiplexing

PALERMO PREMIUM REMOTE



Specifications

Temperature Range: -18 / -24 C

Cooling: Ventilated

Exterior depth 74 or 89 cm

Height: 205 cm or 220 cm as an OPTION

Color: Light Gray Interior, Antracit Gray Exterior (or any other color)

2x End Walls With Polyurethane Insulation And Anti Scratch Paint

Doors With Triple Glass And Anti-Fog System

Doors With Blocker For The Period Of Loading

ECO FREE BLACK Self-closing Glass Doors

White LED Lighting On Each Door For Perfect Visibility

LED 6500K Or 4500K

5 Shelves Of 40 Or 55 Cm On Each Row (plus base shelf)

Shelves with Front Riser and Ticket Strip

Professional Controller Dixell XR60CH

Electrical Resistance For Automatic Defrosting

Electrical Resistance For Condensation Water Evaporation

Electric Panel Included

Thermostatic Valve Included

Solenoid Valve Included

Optional

Extra Shelves As An Option

Plexiglass Separator Between Shelves as an Option

Electrical Resistance For Condensation Water Evaporation as an Option

DISPLAY FREEZER FOR SUPERMARKET WITH EXTERNAL COOLING UNIT

TECHNICAL DRAWING FOR PALERMO PREMIUM

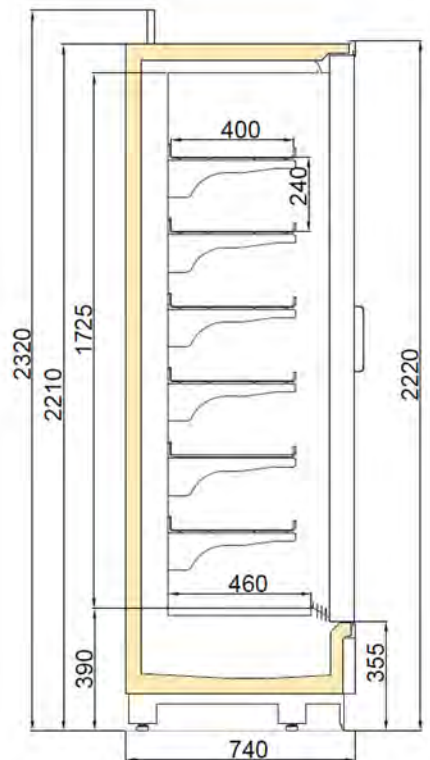
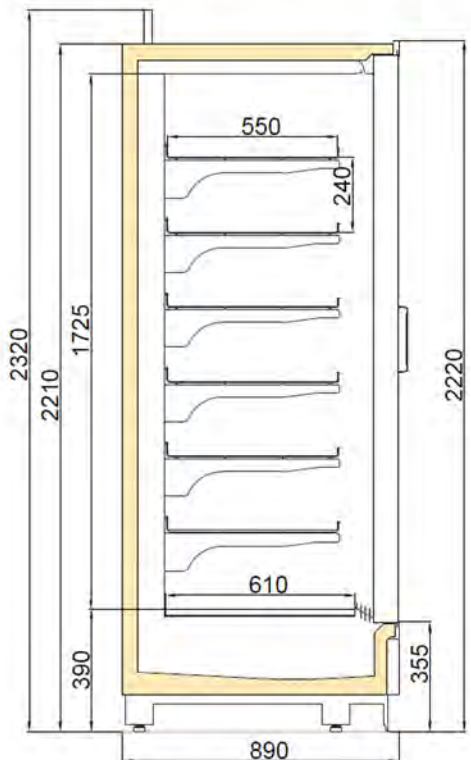
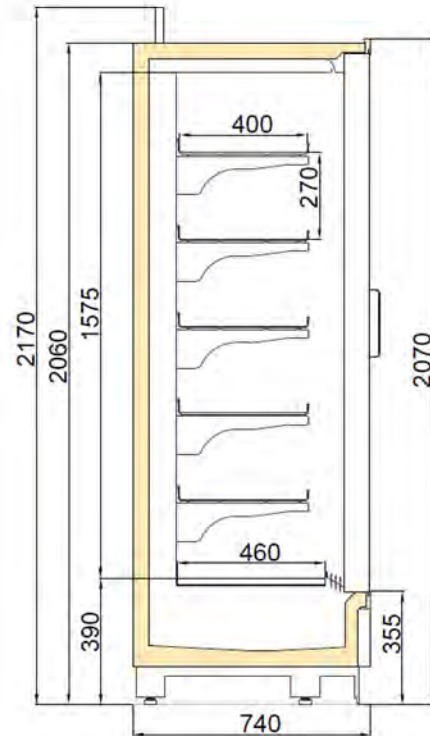
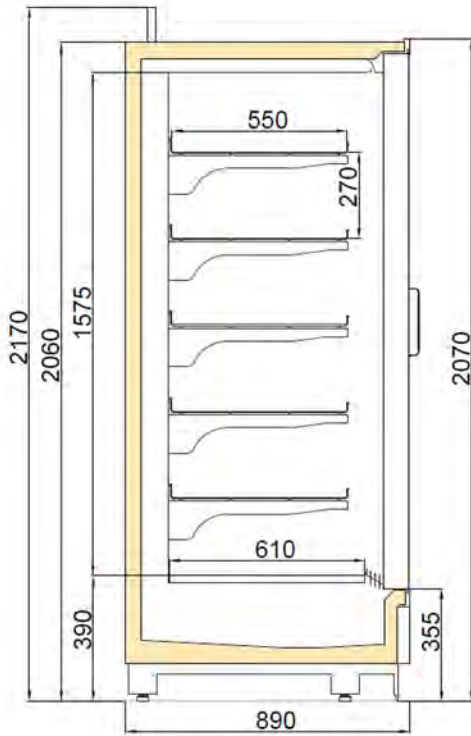



WINE COOLERS
ON OUR WEBSITE: WWW.PETERSCOOLING.COM

WINE COOLER WITH TWO COOLING ZONES WITH INTERNAL COOLING UNIT AND HINGED DOORS



FS100



FS200



FS400



WINE COOLERS

Dimensions

FS100 WINE (1 cooling zone): Exterior 295 x 570 x 860 mm, Interior 227 x 492 x 658 mm

FS200 WINE: Exterior 595 x 570 x 820 mm, Interior 520 x 445 x 605 mm

FS400 WINE: Exterior 595 x 680 x 1760 mm, Interior 515 x 532 x 1585 mm

Specifications

Temperature Range : +5/ +10 C and +10/ +18 C

Ambient Temperature: +16/ +25 C

Cooling: Ventilated

Doors With Double Glass

4 Adjustable Feet

White LED Lighting

Digital Controller

Automatic Defrost

Digital Thermometer

ABS Interior

Hinged Doors

Wooden Shelves Included

Stainless Steel Exterior

Stainless Steel Handle

Silent Model

Vertical Presentation Shelves as an Option

Volume:

FS200 WINE (1 cooling zone): 19 Bottles 750 ml

FS300 WINE: 46 Bottles 750 ml

FS400 WINE: 163 Bottles 750 ml



WINE COOLER WITH TWO COOLING ZONES WITH INTERNAL COOLING UNIT AND HINGED DOORS



FS200



FS300



FS400



WINE COOLERS

Dimensions

FS200 WINE: Exterior 595 x 680 x 820 mm, Interior 520 x 445 x 605 mm

FS300 WINE: Exterior 595 x 680 x 1390 mm, Interior 510 x 540 x 1130 mm

FS400 WINE: Exterior 595 x 680 x 1760 mm, Interior 515 x 532 x 1585 mm

Specifications

Temperature Range : +5 / +10 C and +10 / +18 C

Ambient Temperature: +16 / +25 C

Cooling: Ventilated

Doors With Double Glass

4 Adjustable Feet

White LED Lighting

2 LED Stripes On Door (left, right)

Digital Controller

Automatic Defrost

Digital Thermometer

ABS Interior

Hinged Doors

Wooden Shelves Included

Stainless Steel Handle

Silent Model

Vertical Presentation Shelves As An Option

Volume:

FS200 WINE: 63 Bottles 750ml

FS300 WINE: 119 Bottles 750ml

FS400 WINE: 163 Bottles 750ml





HORIZONTAL COOLERS AND FREEZERS

ON OUR WEBSITE: WWW.PETERSCOOLING.COM

HORIZONTAL MEDICAL FREEZER WITH LID AND DIGITAL CONTROLLER WITH INTERNAL COOLING UNIT



FS20-45FLID



FS30-45FLID



FS40-50FLID

HORIZONTAL COOLERS
AND FREEZERS

Dimensions

FS20-45FLID: Exterior 984 x 705 x 945 mm, Interior 820 x 440 x 705 mm

FS30-45FLID: Exterior 1284 x 705 x 945 mm, Interior 1120 x 440 x 705 mm

FS40-50FLID: Exterior 1504 x 705 x 945 mm, Interior 1340 x 440 x 705 mm



Specifications

Temperature Range : -5/ -45 C

Ambient Temperature: +16/ +35 C

Cooling: Static

Hinged Solid Lid

4 Castors

White LED Lighting

Aluminium Interior

Digital Controller

Manual Defrost

Digital Thermometer

Baskets Included

Lock Included

Volume:

FS200FLID: 278 liters

FS300FLID: 385 liters

FS400FLID: 461 liters



HORIZONTAL FREEZER WITH FLAT OR CURVED LID WITH INTERNAL COOLING UNIT



HORIZONTAL COOLERS
AND FREEZERS

Dimensions

FS200FGLASS: Exterior 720 x 615 x 949 mm, Interior 600 x 495 x 710 mm
FS300FGLASS: Exterior 1010 x 630 x 892 mm, Interior 890 x 510 x 655 mm
FS400FGLASS: Exterior 1300 x 615 x 949 mm, Interior 1180 x 495 x 710 mm
FS500FGLASS: Exterior 1550 x 615 x 949 mm, Interior 1420 x 495 x 710 mm
FS550FGLASS: Exterior 1750 x 615 x 949 mm, Interior 1630 x 495 x 710 mm
FS750FGLASS: Exterior 2055 x 630 x 892 mm, Interior 1930 x 510 x 655 mm



Specifications

Temperature Range : -5/ -24 C
Ambient Temperature: +16/ +35 C
Cooling: Static
Flat Or Curved Glass Lid
4 Castors
Aluminium Interior
Mechanic Controller
Manual Defrost
Thermometer
Baskets Included
Lock Included

Volume:

FS200FGLASS: 176 liters
FS300FGLASS: 296 liters
FS400FGLASS: 352 liters
FS500FGLASS: 427 liters
FS550FGLASS: 540 liters
FS750FGLASS: 670 liters



HORIZONTAL FREEZER WITH LID AND DIGITAL CONTROLLER WITH INTERNAL COOLING UNIT



HORIZONTAL COOLERS
AND FREEZERS

Dimensions

FS200-FLID: Exterior 734 x 700 x 945 mm, Interior 610 x 480 x 725 mm
FS300-FLID: Exterior 984 x 700 x 945 mm, Interior 860 x 480 x 725 mm
FS400-FLID: Exterior 1284 x 700 x 945 mm, Interior 1160 x 480 x 725 mm
FS500-FLID: Exterior 1504 x 700 x 945 mm, Interior 1380 x 480 x 725 mm
FS600-FLID: Exterior 1804 x 700 x 945 mm, Interior 1680 x 480 x 725 mm
FS700-FLID: Exterior 2060 x 700 x 945 mm, Interior 1935 x 480 x 725 mm



Specifications

Temperature Range:
Cooling: 0 / +12 C
Freezing: -14 / -24 C
Ambient Temperature: +16 / +35 C
Cooling: Static
Hinged Solid Lid
4 Castors
White LED Lighting
Aluminium Interior
Digital Controller
Manual Defrost
Digital Thermometer
Baskets Included
Lock Included

Volume:

FS200FLID: 189 liters
FS300FLID: 278 liters
FS400FLID: 385 liters
FS500FLID: 463 liters
FS600FLID: 567 liters
FS700FLID: 675 liters



CAN FREEZER WITH GLASS LID WITH INTERNAL COOLING UNIT



FS77F

Dimensions

Exterior: 567 x 567 x 830 mm

Interior: 454 x 454 x 440 mm



Specifications

Temperature Range : -12 / -24 C

Ambient Temperature: +16 / +35 C

Cooling: Static

Volume: 80 liters

4 Castors

Mechanic Controller

Steel

Baskets Included

Grid Included



COUNTERTOP SCOOP ICE CREAM FREEZER



ICE 2

ICE 3

Dimensions

ICE2: 49x79x17cm - 2 Napoli Pans For Ice Cream

ICE3: 66x79x17cm - 3 Napoli Pans For Ice Cream



Specificatii

Temperature Range :

Freezing: from -10 to -22 C

White LED Lighting as an Option

Controller for Temperature Adjustment

Thermometer

Voltage: 220-240/50

Power Cable Length: 1750 mm

Refrigerant: R290

Cooling: Static



HORIZONTAL DISPLAY FREEZER FOR ICE CREAM WITH INTERNAL COOLING UNIT

HORIZONTAL COOLERS
AND FREEZERS



IC201SCE+SO

IC301SCE+SO

IC401SCE+SO

IC501SCE+SO

Dimensions

IC201SCE+SO	Exterior 720 x 615 x 1295 mm, Interior 500 x 495 x 710 mm
IC301SCE+SO	Exterior 1010 x 615 x 1295 mm, Interior 890 x 495 x 710 mm
IC401SCE+SO	Exterior 1300 x 615 x 1295 mm, Interior 1180 x 495 x 710 mm
IC501SCE+SO	Exterior 1550 x 615 x 1295 mm, Interior: 1420 x 495 x 710 mm



Specifications

- Temperature Range: -14 / -24 C
- Ambient Temperature: +16 / +35 C
- Cooling: Static
- Flat Or Curved Glass Door
- 4 Castors
- Aluminium Interior
- Mechanical Controller
- Manual Defrost
- Thermometer
- Baskets Included
- Lock Included
- Storage Under Baskets

Volum:

- IC201SCE: 176 liters with 4 baskets
- IC301SCE: 296 liters with 7 baskets
- IC401SCE: 352 liters with 9 baskets
- IC501SCE: 427 liters with 11 baskets



HORIZONTAL DISPLAY FREEZER FOR ICE CREAM WITH INTERNAL COOLING UNIT



FSS7 - FSS9COOPING

Dimensions

FSS7COOPING: Exterior 1341 x 723 x 1253 mm, Interior 1217 x 450 x 240 mm

FSS9COOPING: Exterior 1656 x 723 x 1253 mm, Interior 1532 x 450 x 240 mm



Specifications

- Temperature Range: -14 / -20 C
- Ambient Temperature: +16 / +45 C
- Cooling: Static
- 2 Sliding Doors and Serve Over Glass Top
- 4 Double Castors
- Steel Interior - Painted
- White LED Lighting
- Digital Controller
- Automatic Defrost
- Digital Thermometer
- Tray Holder Included
- Lock Included
- Storage Under Baskets

Volume:

FSS7COOPING: 317 liters

FSS9SCOOPING: 423 liters

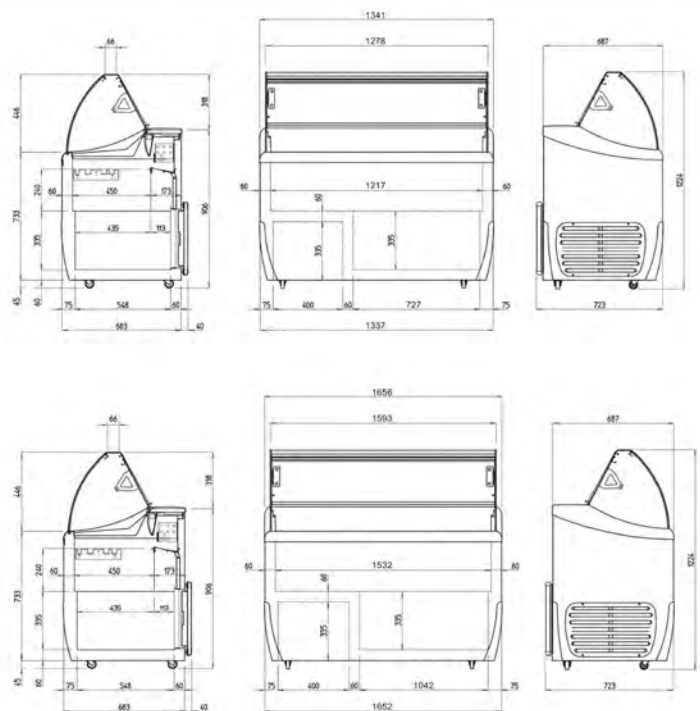

HORIZONTAL DISPLAY FREEZER FOR ICE CREAM WITH INTERNAL COOLING UNIT



MIRABELLA 6-7-9

Dimensions

MIRABELLA 6: Exterior 1270 x 740 x 1290 mm, Interior 1187 x 677 x 1190 mm

MIRABELLA 7: Exterior 1420 x 740 x 1290 mm, Interior 1337 x 677 x 1190 mm

MIRABELLA 9: Exterior 1735 x 740 x 1290 mm mm, Interior 1652 x 677 x 1190 mm



Specifications

Temperature Range: -5/-20 C

Ambient Temperature: +16 / +45 C

Cooling: Static

Serve Over Glass Top

4 Double Castors

INOX Interior

White LED Lighting

Digital Controller

Automatic Defrost

Digital Thermometer

Tray Holder Included

Storage Under Baskets

Volume:

MIRABELLA 6: 276 liters

MIRABELLA 7: 329 liters

MIRABELLA 9: 439 liters

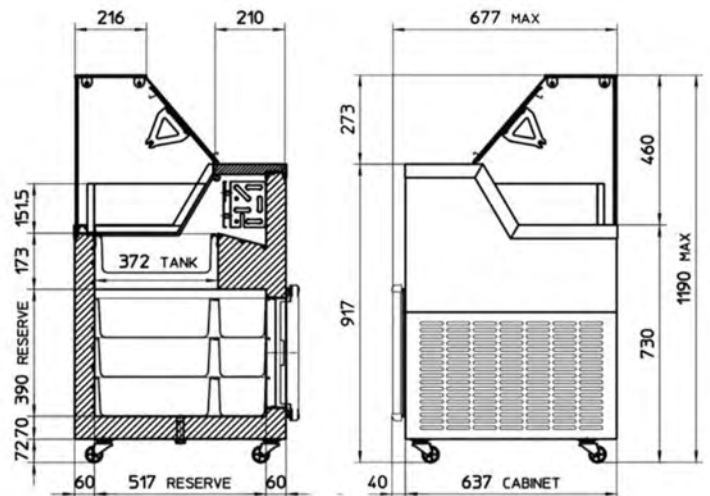

HORIZONTAL DISPLAY FREEZER FOR ICE CREAM WITH INTERNAL COOLING UNIT



HORIZONTAL COOLERS
AND FREEZERS

ISABELLA 132 165

Dimensions

ISABELLA 132: 1317 x 906 x 1372 - 10 Napoli Pans For Ice Cream

ISABELLA 165: 1647 x 906 x 1372 - 13 Napoli Pans For Ice Cream



Specifications

Temperature Range: -14 / -16 C

White LED Lighting

Automatic Defrost

Cooling: Static

Digital Controller

Digital Thermometer

Rear Night Curtain

Storage With Hinged Door

Castors

Voltage: 220-240/50

Energy Consumption: 9.60 kWh / 24h

Power Cable Length: 1750 mm

Refrigerant: R290

Noise Level: 43.6 (very silent)

HORIZONTAL DISPLAY FREEZER FOR ICE CREAM WITH INTERNAL COOLING UNIT



HORIZONTAL COOLERS
AND FREEZERS

MILLENNIUM 150 183 216

Dimensions

- MILLENNIUM 150x10x135cm – 16 Napoli Pans For Ice Cream
- MILLENNIUM 183x10x135cm – 18 Napoli Pans For Ice Cream
- MILLENNIUM 216x10x135cm – 20 Napoli Pans For Ice Cream



Specifications

- Temperature Range -14/ -20 C
- Input Power: 2560 W
- White LED Lighting
- Cooling: Static
- Automatic Defrost
- INOX Interior
- Double Side Glasses
- Digital Controller
- Digital Thermometer
- Rear Night Curtain
- Castors
- Voltage: 220-240/50
- Power Cable Length: 1750 mm
- Refrigerant: R290
- Noise Level: 43.6 (very silent)

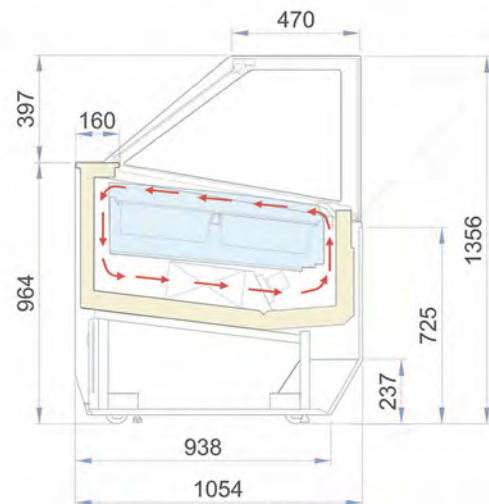

HORIZONTAL COOLER OR FREEZER FOR SUPERMARKET WITH INTERNAL COOLING UNIT



HORIZONTAL COOLERS
AND FREEZERS

FS150, FS189, FS201, FS251

Dimensions

FS150: 151 x 93 x 90 cm
FS189: 189 x 93 x 90 cm
FS201: 201 x 93 x 90 cm
FS251: 251 x 93 x 90 cm



Specifications

Temperature Range:

Freezing -18 / -23 C

Cooling 0 / +8 C

White LED Lighting

2 Sliding Glass Doors

Digital Controller

Adjustable Feet

Shelf System

Cooling: Static or Ventilated

Voltage: 220-240/50

Power Cable Length: 1750 mm

Refrigerant: R290

Noise Level: 43.6 dB

Volume:

FS150: 667 liters

FS189: 870 liters

FS201: 965 liters

FS251: 1216 liters

Castors as an Option

Ticket Strips as an Option

Ice Cream Baskets as an Option

Personalization as an Option

Variable Speed Inverter as an Option

Automatic Defrost as an Option

HORIZONTAL COOLER OR FREEZER FOR SUPERMARKET WITH INTERNAL COOLING UNIT



HORIZONTAL COOLERS
AND FREEZERS

FS201G, FS213G

Dimensions

FS201: 201 x 93 x 90 cm

FS251: 251 x 93 x 90 cm



Specifications

Temperature Range:

Freezing -18 / -23 C

Cooling 0 / +8 C

White LED Lighting

2 Sliding Glass Doors

Digital Controller

Adjustable Feet

Shelf System

Cooling: Static or Ventilated

Voltage: 220-240/50

Power Cable Length: 1750 mm

Refrigerant: R290

Noise Level: 43.6 dB

Volume:

FS201G: 865 liters

FS213G: 1005 liters

Castors as an Option

Ticket Strips as an Option

Ice Cream Baskets as an Option

Personalization as an Option

Variable Speed Inverter as an Option

Automatic Defrost as an Option

WALL AND HORIZONTAL COOLER OR FREEZER FOR SUPERMARKET WITH INTERNAL COOLING UNIT

NEW USED REFURBISHED



AHT KINLEY



HORIZONTAL COOLERS
AND FREEZERS

Dimensions

AHT Kinley 210: Exterior 210x98x237 cm

AHT Kinley 250: Exterior 250x98x237 cm



Specifications

Temperature Range:

Freezing -18 / -24 C

Cooling -2 / +8 C

Ambient Temperature: +16 / +25 C

Cooling: Static or Ventilated

4 Feet

Digital Controller

White LED Lighting

Automatic Defrost

Digital Thermometer

Compressor with Inverter - (ECONOMIC)

Compressor with Variable Speed

Shelves Included

Dividers Included

Basket System Included

Storage Under Baskets

Personalized Design as an Option



Volume:

AHT Kinley 210: 1440 liters

AHT Kinley 250: 1680 liters

HORIZONTAL COOLER OR FREEZER FOR SUPERMARKET WITH INTERNAL COOLING UNIT

NEW USED REFURBISHED



HORIZONTAL COOLERS
AND FREEZERS

AHT-MIAMI-185

AHT-MIAMI-210

AHT-MIAMI-250

Dimensions

AHT Miami 185: Exterior 185x99x83 cm

AHT Miami 210: Exterior 210x85x83 cm

AHT Miami 250: Exterior 250x85x83 cm



Specifications

Temperature Range:

Cooling -2 / +8 C

Freezing -18 / -24 C

Cooling: Static or Ventilated

Door with Curved Glass

6 Feet

Digital Controller

White LED Lighting

Automatic Defrost

Digital Thermometer

Refrigerant: ECO R290

Compressor with Inverter - (ECONOMIC)

Compressor with Variable Speed

Shelves Included

Dividers Included

Basket System Included

Storage Under Baskets

Personalized Design as an Option

Volume:

Miami 185: 720 liters

Miami 210: 780 liters

Miami 250: 920 liters



HORIZONTAL COOLER OR FREEZER FOR SUPERMARKET WITH INTERNAL COOLING UNIT



HORIZONTAL COOLERS
AND FREEZERS

AHT MONTREAL 175, 210, 250

Dimensions

AHT Montreal 175: Exterior 185 x 100 x 91 cm

AHT Montreal 210: Exterior 210 x 100 x 91 cm

AHT Montreal 250: Exterior 250 x 100 x 91 cm



Specifications

Temperature Range:

Cooling -2 / +8 C

Freezing -18 / -24 C

Cooling: Static or Ventilated

Door with Curved Glass

6 Feet

Digital Controller

White LED Lighting

Automatic Defrost

Digital Thermometer

Refrigerant: ECO R290

Compressor with Inverter - (ECONomic)

Compressor with Variable Speed

Shelves Included

Dividers Included

Basket System Included

Storage Under Baskets

Personalized Design as an Option

Volume:

Montreal 175: 1002 liters

Montreal 210: 1233 liters

Montreal 250: 1497 liters

ISLAND COOLERS AND FREEZERS

ON OUR WEBSITE: WWW.PETERSCOOLING.COM

ISLAND COOLER FOR SUPERMARKET WITH INTERNAL COOLING UNIT



PALMA 102, 133, 200



ISLAND COOLERS
AND FREEZERS

Dimensions

PALMA 102: 102 x 101 x 100 cm

PALMA 133: 133 x 101 x 100 cm

PALMA 200: 200 x 101 x 100 cm

Specifications

Temperature Range: -1/ +4 C

Digital Controller Dixell XR60CH

Cooling: Ventilated

Sliding Glass Doors

Refrigerant: Economic and Ecologic R290

Feet with Castors and Safety Brakes

Weight: 142 kg

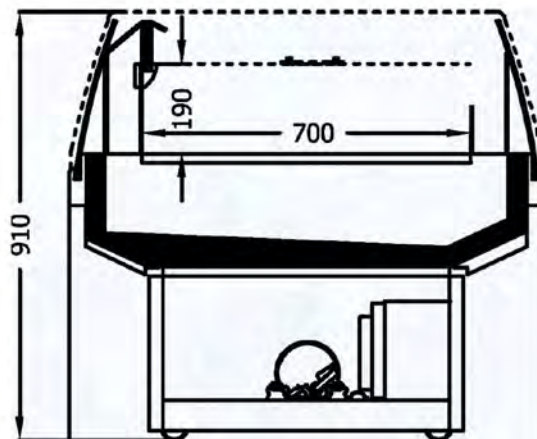

ISLAND COOLER FOR SUPERMARKET WITH INTERNAL COOLING UNIT



FS90ISLAND

FS125ISLAND

Dimensions

FS90ISLAND: Exterior 900 x 845 x 971 mm, Interior 860 x 555 x 220 mm

FS125ISLAND: Exterior 1250 x 1203 x 971 mm, Interior 1210 x 904 x 220 mm

Specifications

Temperature Range: -2/ +5 C

Ambient Temperature: +16/ +25 C

Cooling: Static or Ventilated

Air Curtain or Sliding Glass Doors

Volume 153, 270 liters

4 Castors

Stainless Steel Interior

Digital Controller

Automatic Defrost

Digital Thermometer

Personalized Design as an Option



ISLAND COOLER OR FREEZER FOR SUPERMARKET WITH INTERNAL COOLING UNIT



ISLAND COOLERS
AND FREEZERS

FS200ISLAND

Dimensions

Exterior 1255 x 1015 x 962 mm
Interior 1075 x 705 x 295 mm



Specifications

Temperature Range:
Freezing -18 / -24 C
Cooling -2 / +5 C
Ambient Temperature: +16 / +25 C
Cooling: Static or Ventilated
Air Curtain or Glass Lid
Volume: 200 liters
4 Castors
Stainless Steel Interior
Digital Controller
White LED Lighting
Automatic Defrost
Digital Thermometer
Shelf Included
Personalized Design as an Option



ISLAND COOLER OR FREEZER FOR SUPERMARKET WITH INTERNAL COOLING UNIT



ISLAND COOLERS
AND FREEZERS

AHT MACAO 100, 145, 210

Dimensions

MACAO 100: 99 x 85 x 90 cm

MACAO 145: 146 x 85 x 90 cm

MACAO 210: 210 x 85 x 90 cm



Specifications

Temperature Range:

Freezing -18 / -24 C

Cooling -2 / +5 C

Ambient Temperature: +16 / +25 C

Cooling: Static or Ventilated

Air Curtain or Glass Lid

4 Castors

Refrigerant: R290

Digital Controller

White LED Lighting

Automatic Defrost

Digital Thermometer

Dividers, Baskets, Shelves Included

Personalized Design as an Option



ISLAND COOLER OR FREEZER FOR SUPERMARKET WITH INTERNAL COOLING UNIT



ISLAND COOLERS
AND FREEZERS

ISLAND COOLER / FREEZER 150, 200, 250

Dimensions

ISLAND COOLER / FREEZER 150: 148 x 104 x 99 cm

ISLAND COOLER / FREEZER 200: 213 x 104 x 99 cm

ISLAND COOLER / FREEZER 250: 253 x 104 x 99 cm



Specifications

Temperature Range:

Freezing -16 / -22 C

Cooling 0 / +6 C

Ambient Temperature: +16 / +25 C

Cooling: Static or Ventilated

Air Curtain or Glass Lid

4 Feet

Refrigerant: R290

Digital Controller

Automatic Defrost

Digital Thermometer

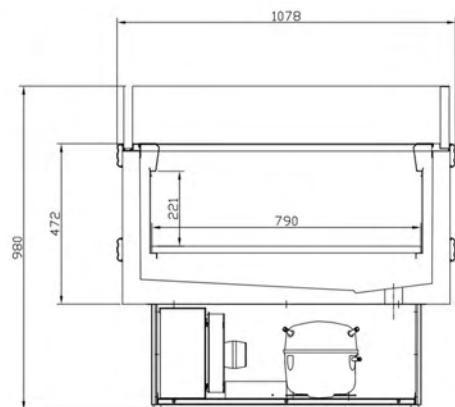

GLASS CABINETS

ON OUR WEBSITE: WWW.PETERSCOOLING.COM

NEUTRAL GLASS CABINET WITHOUT COOLING OR HEATING UNIT



GLASS CABINETS

MALMO NEUTRAL



	Dimensions				
Length (cm)	100	125	150	175	200
Width (cm)	78	78	78	78	78
Height (cm)	135	135	135	135	135

Specifications

- Glass Shelves
- Stainless Steel Base
- Special Lighting for Perfect Visibility
- LED Lighting for Each Shelf
- Rear Closing with Sliding Doors
- Any Color of Choice

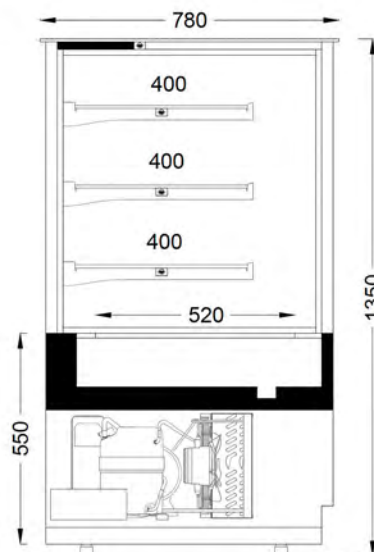

WARM GLASS CABINET FOR PASTRY WITH INTERNAL HEATING UNIT



MALMO WARM



GLASS CABINETS



Dimensions

	100	125	150	175	200
Length (cm)	100	125	150	175	200
Width (cm)	78	78	78	78	78
Height (cm)	135	135	135	135	135

Specifications

- Temperature Range: +40 / +80 C
- Ambient Temperature: +16 / +45 C
- Heating by Resistance and Ventilation
- Special Ventilation System (Products Do Not Dry)
- Mechanical Controller
- Stainless Steel Base
- LED Lighting for Each Shelf
- Rear Closing with Sliding Doors
- Any Color of Choice

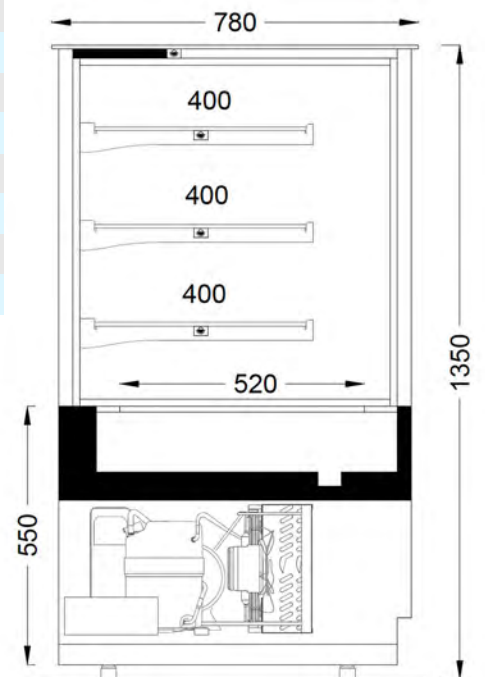

REFRIGERATED GLASS CABINET FOR CAKES

WITH INTERNAL COOLING UNIT



MALMO COLD

GLASS CABINETS

Dimensions

	100	125	150	175	200
Length (cm)	100	125	150	175	200
Width (cm)	78	78	78	78	78
Height (cm)	135	135	135	135	135



Specifications

- Temperature Range: +2 / +8 C
- Ambient Temperature: +16 / +25 C
- Cooling: Ventilated
- Special Ventilation System (Products Do Not Dry)
- Digital Controller Dixell XR60CH
- Automatic Defrost with Electrical Resistance
- Stainless Steel Base
- Stainless Steel Display Surface
- LED Lighting Under Each Shelf
- Rear Closing with Sliding Doors
- Any Color of Choice

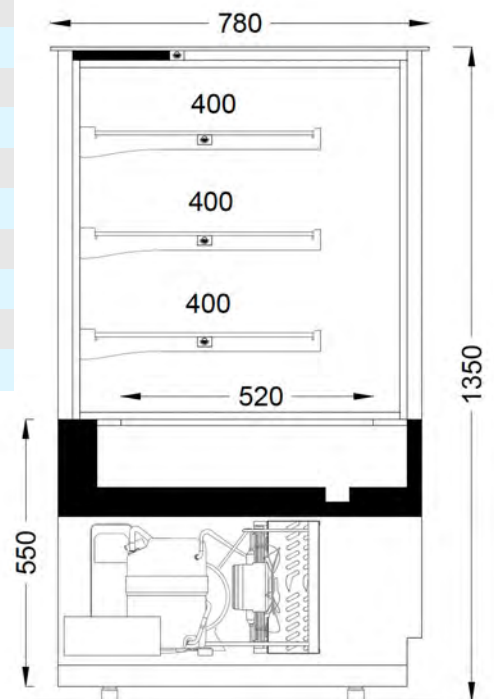

REFRIGERATED DISPLAY COUNTER WITH FLAT OR CURVED GLASS AND INTERNAL COOLING UNIT



MALMO INOX BANC



GLASS CABINETS

Dimensions

70x56x67 cm

90x56x67 cm

Specifications

- Temperature Range: +2/ +8 C
- Ambient Temperature: +16/ +25 C
- Cooling: Ventilated
- Special Ventilation System (Products Do Not Dry)
- Digital Controller Dixell
- Automatic Defrost
- Stainless Steel Base
- Stainless Steel Display Surface
- Stainless Steel Exterior
- Rear Closing with Sliding Doors

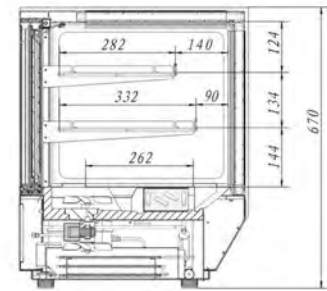
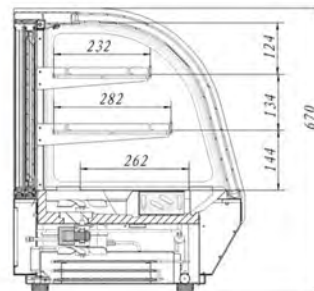

REFRIGERATED DISPLAY COUNTER FOR CAKES

WITH 2 SHELVES, FLAT GLASS FRONT AND INTERNAL COOLING UNIT



MALMO INOX 2 SHELVES

Dimensions

- 90x75x121 cm
- 120x75x121 cm
- 150x75x121 cm



GLASS CABINETS

Specifications

- Temperature Range: +2 / +8 C
- Ambient Temperature: +16 / +25 C
- Cooling: Ventilated
- Special Ventilation System (Products Do Not Dry)
- Digital Controller Dixell
- Automatic Defrost
- Stainless Steel Base
- Stainless Steel Display Surface
- Stainless Steel Exterior
- LED Lighting Under Each Shelf
- Rear Closing with Sliding Doors

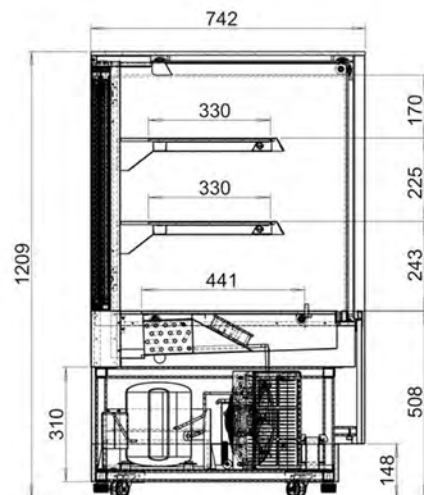

REFRIGERATED DISPLAY COUNTER FOR CAKES

WITH 3 SHELVES, FLAT OR CURVED GLASS FRONT AND INTERNAL COOLING UNIT



MALMO INOX 3 SHELVES

Dimensions

- 90x75x131 cm
- 120x75x131 cm
- 150x75x131 cm



Specifications

- Temperature Range: +2/ +8 C
- Ambient Temperature: +16/ +25 C
- Cooling: Ventilated
- Special Ventilation System (Products Do Not Dry)
- Digital Controller Dixell
- Automatic Defrost
- Stainless Steel Base
- Stainless Steel Display Surface
- Stainless Steel Exterior
- LED Lighting Under Each Shelf
- Rear Closing with Sliding Doors
- Anti Mist Front Glass

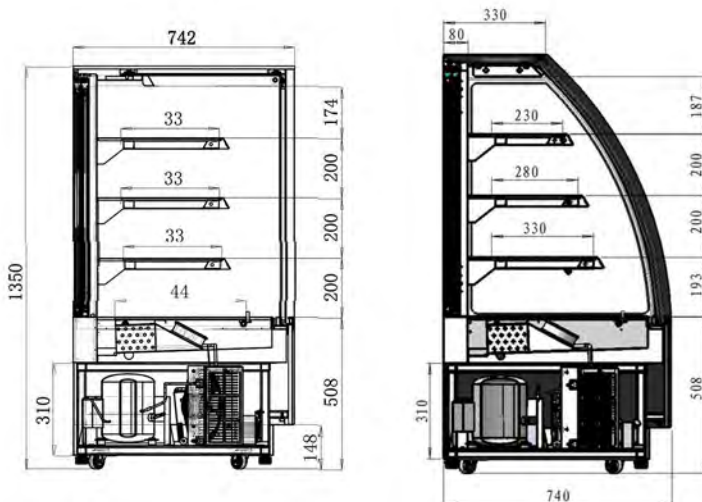

GLASS CABINETS

REFRIGERATED DISPLAY CASE COUNTERTOP FOR CAKES

VERTICAL, WITH HINGED DOOR AND INTERNAL COOLING UNIT



FS60, 80 BANC



Dimensions

FS60BANC - Exterior 428 x 386 x 855 mm, Interior 400 x 358 x 460 mm

FS80BANC - Exterior 428 x 386 x 1000 mm, Interior 400 x 358 x 610 mm

Specifications

- Temperature Range: +2 / +8 C
- Ambient Temperature: +16 / +25 C
- Cooling: Ventilated
- Special Ventilation System (Products Do Not Dry)
- Digital Controller Dixell
- Automatic Defrost
- Stainless Steel Base
- Stainless Steel Display Surface
- Stainless Steel Exterior
- LED Lighting Under Each Shelf
- Rear Closing with Hinged Door

Volume:

FS60BANC - 60 liters

FS80BANC - 80 liters

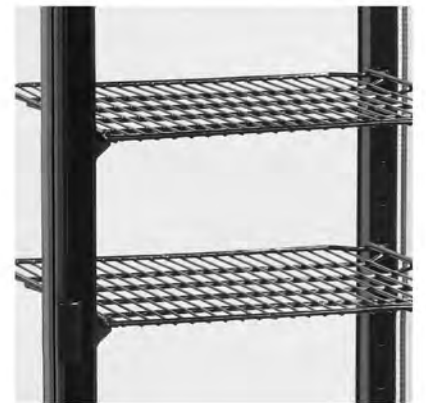

REFRIGERATED DISPLAY CASE FOR CAKES

VERTICAL, WITH HINGED DOOR AND INTERNAL COOLING UNIT



FS200 VERTICAL



Dimensions

FS200VERTICAL - Exterior 706 x 706 x 1800 mm, Interior 638 x 638 x 1180 mm

Specifications

- Temperature Range: +2/ +8 C
- Ambient Temperature: +16/ +25 C
- Volume: 468 liters
- Cooling: Ventilated
- Special Ventilation System (Products Do Not Dry)
- Digital Controller Dixell
- Automatic Defrost
- Stainless Steel Base
- Stainless Steel Display Surface
- Stainless Steel Exterior
- LED Lighting from 4 Sides
- Rear Closing with Hinged Door

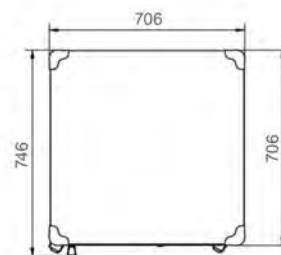
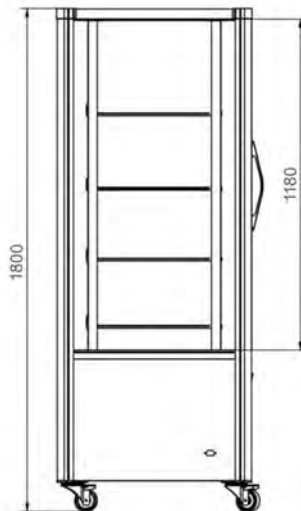
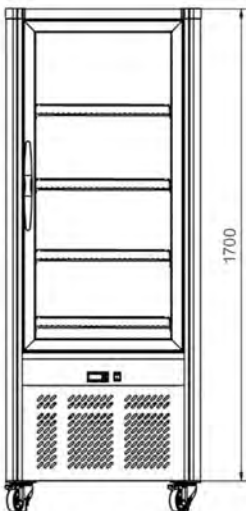

REFRIGERATED OR FREEZING DISPLAY CASE

VERTICAL, UNIVERSAL, WITH INTERNAL COOLING UNIT



FS400 UNIVERSAL



Dimensions

FS400UNIVERSAL - Exterior 650 x 650 x 1950 mm, Interior 588 x 516 x 1200 mm

Specifications

- Temperature Range: Cooling +2/ +8 C
- Freezing -18/ -22 C
- Ambient Temperature: +16/ +25 C
- Cooling: Ventilated
- Special Ventilation System (Products Do Not Dry)
- Digital Controller Dixell
- 4 Castors
- Automatic Defrost
- Steel Exterior - Painted
- Adjustable Shelves
- LED Lighting (4 vertical LED)
- Special Lighting for Perfect Visibility
- Rear Closing with Hinged Door

Volume:
364 liters



SERVE OVER COUNTER
ON OUR WEBSITE: WWW.PETERSCOOLING.COM

SERVE OVER COUNTER
WITH INTERNAL OR EXTERNAL COOLING UNIT



HUSTON



OPTIONAL
SERVE OVER
COUNTER

Optional

- Telescopic Windows as an Option
- Divider with Stainless Steel Feet as an Option
- Support for Scale / Slicer / Cash Register as an Option
- Support for Paper as an Option
- Support for Knives as an Option
- 2 or 3 Levels of Tray as an Option

Dimensions

Length (mm)	1250	1560	1875	2500	3120	3750
End Walls (mm)	40	40	40	40	40	40

Specifications

- Temperature Range: 0 / +5 C
- Ambient Temperature: +16 / +25 C
- Case and Base from Painted Sheet Metal
- Cooling: Semi-Ventilated
- Stainless Steel Display Surface and Worktop
- Stainless Steel Air Intake (Front and Rear)
- Internal or External Cooling Unit
- Refrigerant: Economical and Ecological
- Equipped with Storage and Hinged Doors
- 2x End Walls With Polyurethane Insulation
- Rear Closing with PlexiGlass
- Professional Controller Dixell XR06CX
- LED Lighting Special for Deli, Meat and Dairy
- Adjustable Feet
- Electrical Resistance for Automatic Defrosting

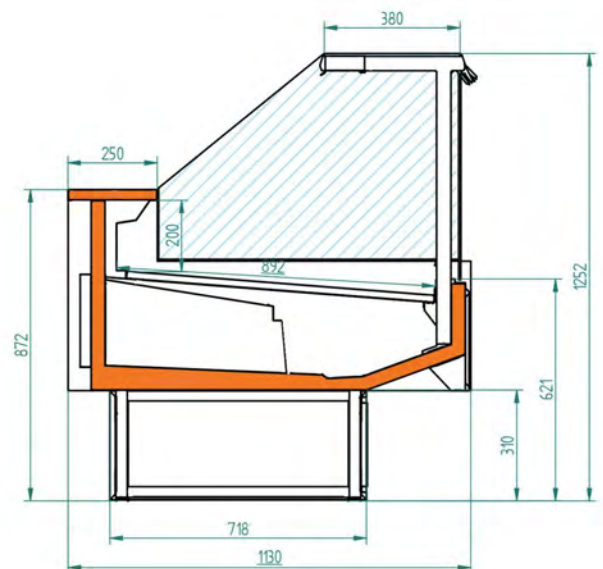

SERVE OVER COUNTER WITH INTERNAL COOLING UNIT



SGL



Dimensions

Length (mm) 1300 1600 1900 2600



Specifications

- Temperature Range: -2 / +8 C
- Ambient Temperature: +16 / +25 C
- Cooling: Static
- White LED Lighting
- Digital Controller Dixell XR06CX
- Automatic Defrost
- Stainless Steel Worktop
- Stainless Steel Display Surface
- Rear Closing with PlexiGlass
- Equipped with Storage

Optional

- Support for Scale on Worktop
- Support for Cutting on Worktop
- Support for Paper
- Support for Knives
- Divider
- Interior Entirely Made of Stainless Steel
- Special Lighting for Deli and Meat
- 2 or 3 levels of tray
- Any Color of Choice

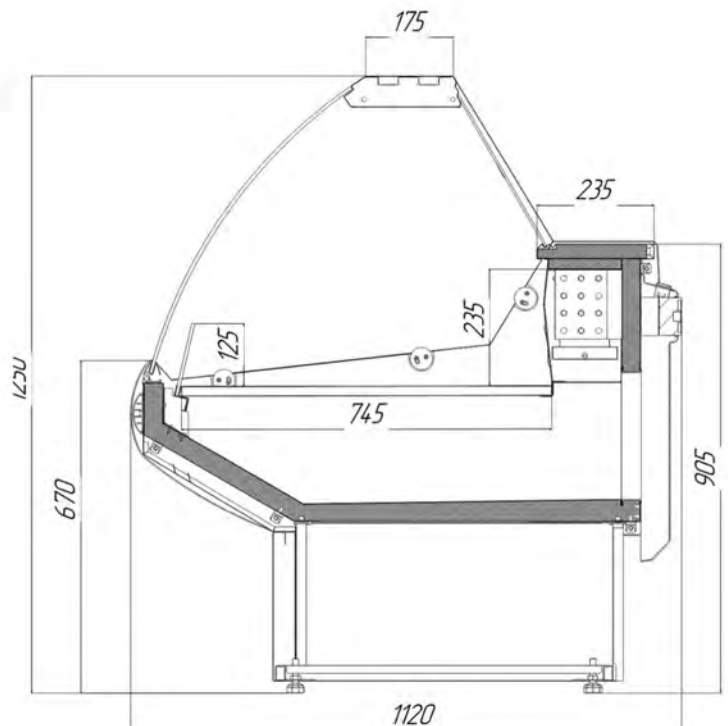

SERVE OVER
COUNTER

SERVE OVER COUNTER
WITH INTERNAL OR EXTERNAL COOLING UNIT



AUSTIN

Dimensions

Length (mm)	1250	1560	1875	2500	3120
-------------	------	------	------	------	------



SERVE OVER COUNTER

Specifications

- Temperature Range: +2/ +5 C
- Ambient Temperature: +16/ +25 C
- Cooling: Ventilated
- Digital Thermometer in Front
- Digital Controller Dixell XR06CX
- Automatic Defrosting with Electrical Resistance
- Stainless Steel Worktop
- Stainless Steel Display Surface
- Rear Closing with PlexiGlass
- Equipped with Storage

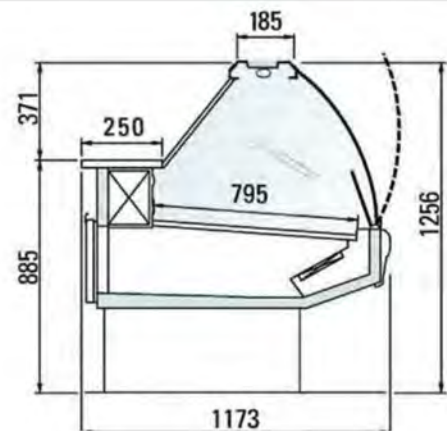

Optional

- Support for Scale on Worktop
- Support for Cutting on Worktop
- Support for Paper
- Divider
- Interior Entirely Made of Stainless Steel
- Special Lighting for Deli and Meat
- 2 or 3 Levels of Tray
- Any Color of Choice

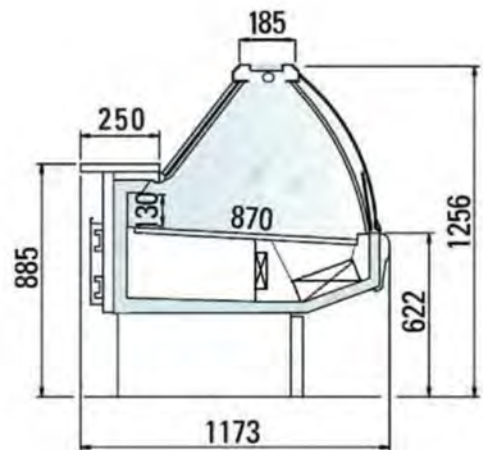

SERVE OVER COUNTER
WITH INTERNAL OR EXTERNAL COOLING UNIT



MODENA PREMIUM

Dimensions

Length (mm) 1000 1320 2000 2600 2900 3200 3872



SERVE OVER
COUNTER

Specifications

Temperature Range: -1 / +3 C
 Ambient Temperature: +16 / +25 C
 Cooling: Semi-Ventilated
 Stainless Steel Case and Base
 Stainless Steel Display Surface and Worktop
 Heated Worktop with Anti-condensation
 Stainless Steel Air Intake (Front and Rear)
 Internal or External Cooling Unit
 Refrigerant: Economical and Ecological
 Telescopic Windows Included
 Ventilated Front Glasses for Defogging
 Double Anti-fog End Walls
 Equipped with Storage and Double Glass Doors
 End Walls : Polyurethane Insulation, Anti Scratch Paint
 Rear Closing with PlexiGlass
 Professional Controller Dixell XR60CH
 Special Lighting for Deli, Meat and Dairy
 230V socket for Scale or Slicer
 Adjustable Feet
 Electrical Resistance for Automatic Defrosting
 Electrical Resistance for Condensation Water Evaporation

Optional

Divider with Stainless Steel Feet as an Option
 Support for Scale / Slicer / Cash Register as an Option
 Support for Paper as an Option
 Support for Knives as an Option
 2 or 3 Levels of Tray as an Option
 Glass Shelves (temperature +2 / +4 grade C) as an Option
 Stainless Steel frontal bar for Glass Protection as an Option



SERVE OVER COUNTER WITH INTERNAL OR EXTERNAL COOLING UNIT

TECHNICAL DRAWING FOR MODENA PREMIUM

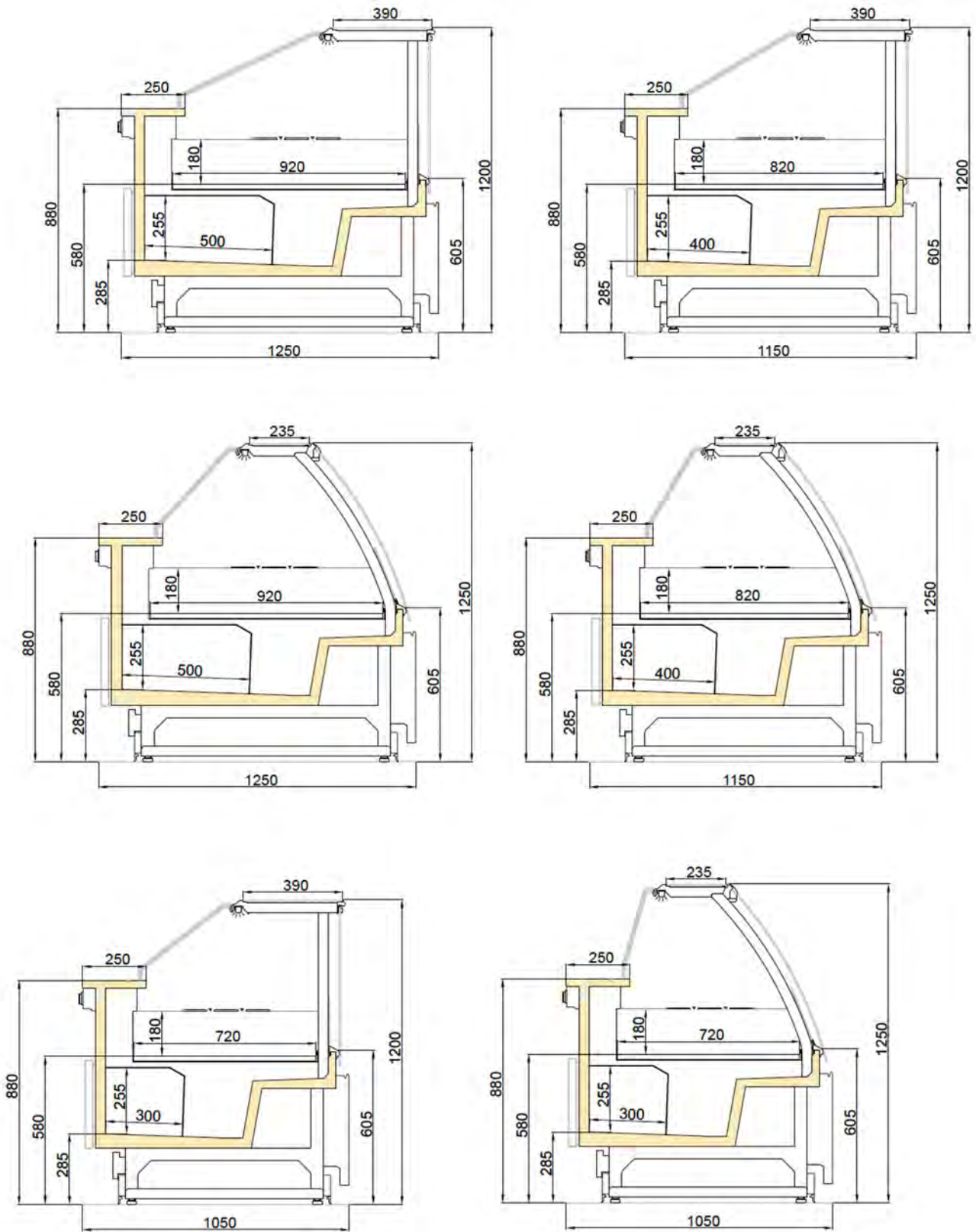

SERVE OVER
COUNTER

SERVE OVER COUNTER
WITH INTERNAL OR EXTERNAL COOLING UNIT



TARNITA

Dimensions

Length (mm)	1250	1560	1875
End Walls (mm)	40	40	40



SERVE OVER COUNTER

Specifications

- Temperature Range: +2/+5 C
- Ambient Temperature: +16 / +25 C
- Cooling: Ventilated
- Digital Thermometer in Front
- Digital Controller Dixell XR06CX
- Automatic Defrosting with Electrical Resistance
- Stainless Steel Worktop
- INStainless Steel OX Display Surface
- Rear Closing with PlexiGlass
- Equipped with Storage
- LED Lighting

Optional

- Support for Scale on Worktop
- Support for Cutting on Worktop
- Support for Paper
- Divider
- Interior Entirely Made of Stainless Steel
- Special LED Lighting for Deli and Meat
- 2 or 3 levels of tray
- Any Color of Choice

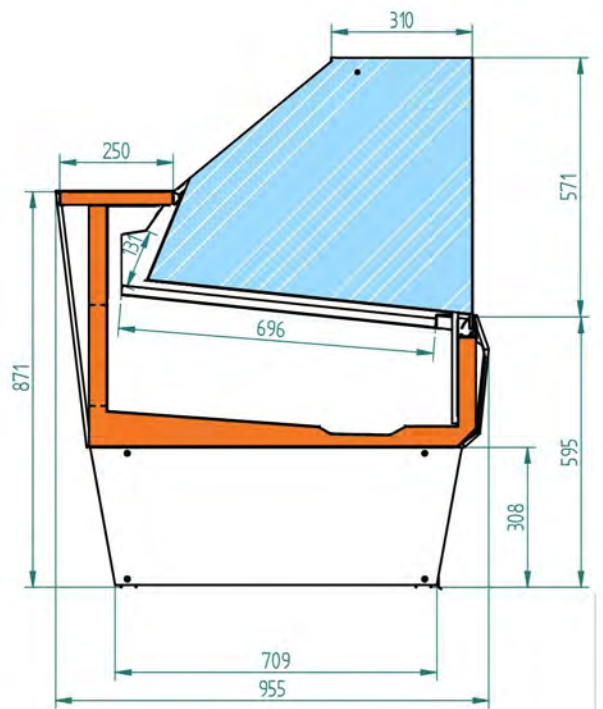



SUPERMARKET COOLERS AND FREEZERS

ON OUR WEBSITE: WWW.PETERSCOOLING.COM

DISPLAY COOLER FOR SUPERMARKET WITH INTERNAL COOLING UNIT



DORTMUND FULLGLASS ECO

Specifications

- Temperature Range: -1/ +3 C
- Color: Black Interior and Exterior
- External Dimensions: 132x74x201 cm
- Internal Dimensions: 125x45x154 cm
- Volume: 1292 liters
- Internal Cooling Unit ECONOMIC R290
- Energy Consumption: : 5.87 kWh / 24h
- Input Power: 550W
- 2x Glass Side Walls
- Double Glass Doors with Anti-fog System, Blocker and Self-Closing System
- ECO FULL GLASS Doors with Thin Frame
- White LED Lighting On Each Door
- LED Under Each Shelf
- LED 6500K
- 5 Shelves of 45 cm plus base
- Front Riser and Ticket Strip Included
- Professional Controller
- Electrical Resistance For Automatic Defrosting
- Electrical Resistance For Condensation Water Evaporation
- Castors

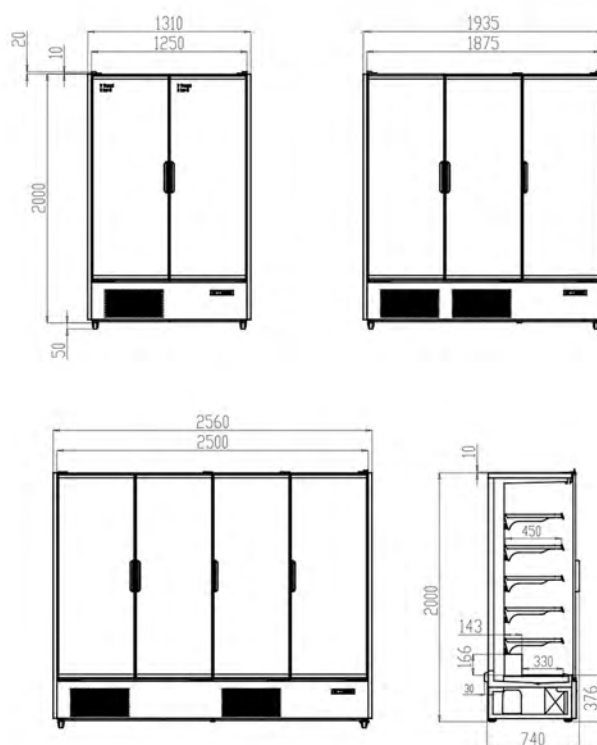

DISPLAY COOLER FOR SUPERMARKET WITH INTERNAL COOLING UNIT



DORTMUND FULLGLASS ECO

SUPERMARKET
COOLERS
AND FREEZERS

Specifications

- Temperature Range: -1/ +3 C
- Color: Black Interior and Exterior
- External Dimensions : 194x74x201cm
- Internal Dimensions : 187x45x154cm
- Volume: 1939 liters
- Internal Cooling Unit ECONOMIC R290
- Energy Consumption: : 8.13 kWh / 24h
- Input Power: 980W
- 2x Glass Side Walls
- Double Glass Doors with Anti-fog System, Blocker and Self-Closing System
- ECO FULL GLASS Doors with Thin Frame
- White LED Lighting On Each Door
- LED Under Each Shelf
- LED 6500K
- 5 Shelves of 45 cm plus base
- Front Riser and Ticket Strip Included
- Professional Controller
- Electrical Resistance For Automatic Defrosting
- Electrical Resistance For Condensation Water Evaporation
- Castors

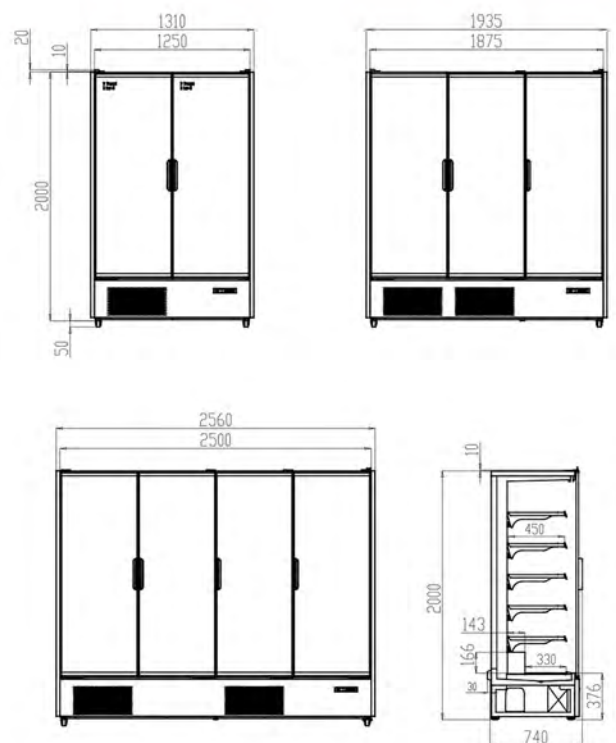

DISPLAY COOLER FOR SUPERMARKET WITH INTERNAL COOLING UNIT



DORTMUND FULLGLASS ECO

Specifications

- Temperature Range: -1 / +3 C
- Color: Black Interior and Exterior
- External Dimensions : 257x74x201cm
- Internal Dimension : 250x45x154cm
- Volume: 2585 liters
- Internal Cooling Unit ECONOMIC R290
- Energy Consumption: : 10.2 kWh / 24h
- Input Power: 1060 W
- 2x Glass Side Walls
- Double Glass Doors with Anti-fog System, Blocker and Self-Closing System
- ECO FULL GLASS Doors with Thin Frame
- White LED Lighting On Each Door
- LED Under Each Shelf
- LED 6500K
- 5 Shelves of 45 cm plus base
- Front Riser and Ticket Strip Included
- Professional Controller
- Electrical Resistance For Automatic Defrosting
- Electrical Resistance For Condensation Water Evaporation
- Castors

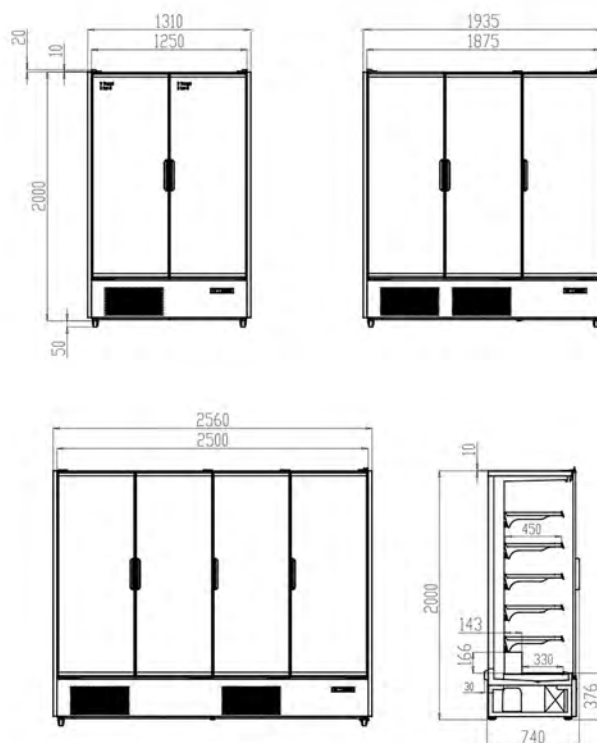

DISPLAY COOLER FOR SUPERMARKET

SEMI-VERTICAL WITH INTERNAL OR EXTERNAL COOLING UNIT



Length

100, 135, 200, 260, 293, 382 cm

BERLIN PREMIUM

Specifications

Temperature Range: -1/ +4 grade C
 Hinged or Sliding Doors
 Flat / Curved Glass or Air Curtain
 Height: 160cm
 Color: Light Gray Interior, Antracit Gray Exterior
 or Any Color of Choice
 Internal or External Cooling Unit
 Stainless Steel Case
 Stainless Steel Evaporator Base
 2x Double Glass Side Walls
 Double Glass Doors with Anti-Fog System
 Doors with Blocker for the Period of Loading
 Self-Closing Doors
 ECO FREE BLACK Doors
 Any Color of Choice
 LED Lighting on the Upper Part
 LED 6500K



3 Shelves plus Base, 48 or 64 cm (base)
 + 40 cm + 35 cm + 30 cm
 Shelves Equipped with Support, Front Riser
 and Ticket Strip
 Professional Controller Dixell XR60CH
 Electrical Resistance For Automatic Defrosting
 Bar and Hook System as an Option
 Extra Shelves as an Option
 PlexiGlass Divider Between Shelves as an Option
 LED Lighting on Each Door as an Option
 Special LED for Deli and Meat as an Option
 LED Lighting Under Each Shelf as an Option
 Interior Entirely Made of Stainless Steel as an Option
 Electrical Resistance For Condensation Water
 Evaporation as an Option

SUPERMARKET
COOLERS
AND FREEZERS

DISPLAY COOLER FOR SUPERMARKET SEMI-VERTICAL WITH INTERNAL OR EXTERNAL COOLING UNIT

TECHNICAL DRAWING FOR BERLIN PREMIUM



DISPLAY COOLER FOR SUPERMARKET

WITH AIR CURTAIN AND **INTERNAL COOLING UNIT**



DORTMUND PREMIUM



Specifications

- Temperature Range: 0/ +4 C
- Height: 205 or 220 cm as an Option
- Depth: 89 or 74 cm as an Option
- Color: Light Gray Interior, Antracit Gray Exterior (or Any Color of Choice)
- Internal Cooling Unit
- Stainless Steel Case
- Stainless Steel Evaporator Base
- 2x Side Walls with Mirror, and Special Dark Gray Anti Scratch Paint
- Night Curtain Included
- LED Lighting on the Upper Part
- LED 6500K
- 4 Shelves of 40 cm on Each Row (plus base) with Front Riser and Ticket Strip
- Professional Controller Dixell XR60CH
- Electrical Resistance For Automatic Defrosting
- Electrical Resistance For Condensation Water Evaporation

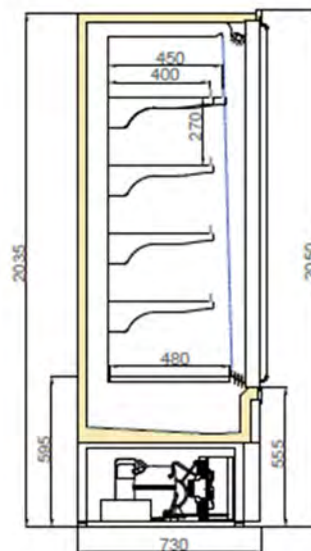

SUPERMARKET
COOLERS
AND FREEZERS

Optional

- Glass Side Walls as an Option
- Bar and Hook System as an Option
- Hinged or Sliding Doors as an Option
- Extra Shelves as an Option
- Special LED for Deli and Meat as an Option
- Interior Entirely Made of INOX as an Option
- Shelves of 45 and 50 cm as an Option
- Height of Base of 37 cm or 55 cm
- LED Lighting Under Each Shelf

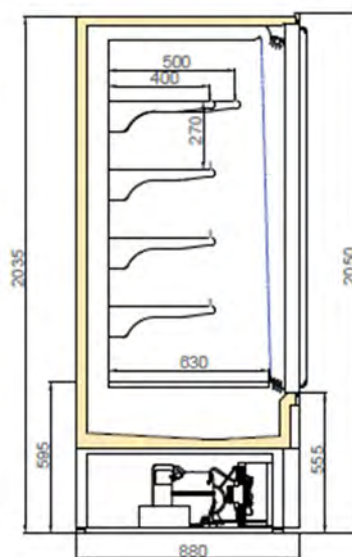
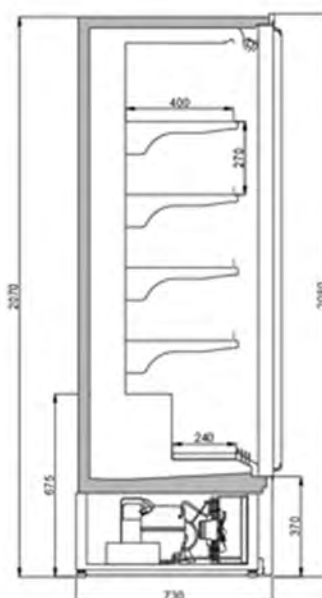

DISPLAY COOLER FOR SUPERMARKET WITH DOUBLE DOORS AND **INTERNAL COOLING UNIT**

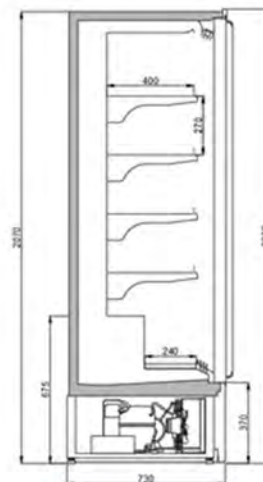

Dimensions

Length (mm) 1000 1320 2000 2600

DORTMUND PREMIUM



Specifications

- Temperature Range: -1/ +3 C
- Height: 205 or 220 cm as an Option
- Depth: 89 or 74 cm as an Option
- Color: Light Gray Interior, Antracit Gray Exterior (or Any Color of Choice)
- Internal Cooling Unit
- Stainless Steel Case
- Stainless Steel Evaporator Base
- 2x Side Walls with Mirror, and Special Dark Gray Anti Scratch Paint
- Double Glass Doors with Anti-Fog System
- Doors With Blocker For The Period Of Loading
- Self-Closing Doors
- ECO FREE BLACK Doors
- LED Lighting on the Upper Part
- LED Lighting on Each Door
- LED 6500K
- 4 Shelves of 45 cm on Each Row (plus base)
- Glass Front Riser and Ticket Strip
- Professional Controller Dixell XR60CH
- Electrical Resistance For Automatic Defrosting
- Electrical Resistance For Condensation Water Evaporation

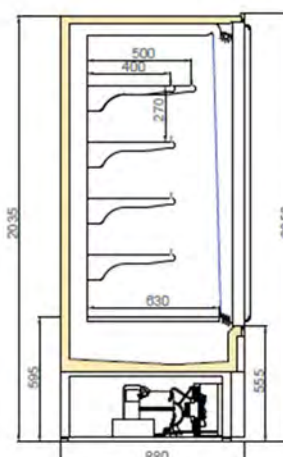
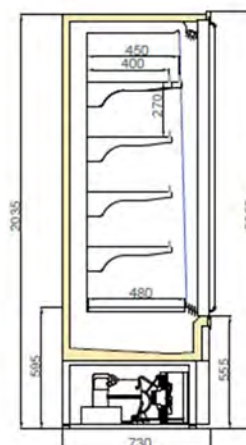

Optional

- Glass Side Walls as an Option
- Bar and Hook System as an Option
- Extra Shelves as an Option
- Special LED for Deli and Meat as an Option
- Interior Entirely Made of Stainless Steel as an Option
- Shelves of 45 and 50 cm as an Option
- PlexiGlass Divider Between Shelves as an Option
- Full Glass Doors (without frame) as an Option

SUPERMARKET
COOLERS
AND FREEZERS

DISPLAY COOLER FOR SUPERMARKET WITH AIR CURTAIN OR DOORS AND **EXTERNAL COOLING UNIT**



Dimensions

Length (mm) 1000 1320 2000 2600 2900 3200 3872

DORTMUND PREMIUM

Specifications

Temperature Range: -1/ +3 C

Cooling: Ventilated

Ideal for Meat, Deli, Dairy, Drinks and Vegetables

Depth: 73, 90, 100 and 110 cm

Height: 205 cm or 220 cm as an Option

Color: Light Gray Interior, Antracit Gray Exterior (or Any Color of Choice)

Stainless Steel Case

Stainless Steel Evaporator Base

2x Side Walls with Mirror, and Special Dark Gray Anti Scratch Paint

Double Glass Doors with Anti-Fog System

Doors With Blocker For The Period Of Loading

Self-Closing Doors

ECO FREE BLACK Doors

LED Lighting on the Upper Part and on Each Door for Perfect Visibility

LED 4500 or 6500K

4 Shelves of 45 cm on Each Row (plus base) with Glass Front Riser and Ticket Strip

Professional Controller Dixell XR60CH

Electrical Resistance For Automatic Defrosting

Electrical Panel Included

Thermostatic Valve Included

Solenoid Valve Included

Optional

Interior Entirely Made of Stainless Steel as an Option

Full Glass Doors (without frame) as an Option

LED Lighting for Deli and Meat as an Option

Electrical Resistance For Condensation Water Evaporation as an Option

Lighting Under Each Shelf as an Option

Bar for Hooks as an Option

Hooks for Deli or Meat as an Option

Shelves: 50 cm and 60 cm as an Option

PlexiGlass Divider as an Option

Glass Side Walls as an Option

DISPLAY COOLER FOR SUPERMARKET WITH DOUBLE DOORS AND EXTERNAL COOLING UNIT

TECHNICAL DRAWING FOR DORTMUND PREMIUM



SUPERMARKET
COOLERS
AND FREEZERS

DISPLAY COOLER FOR SUPERMARKET

WITH AIR CURTAIN OR DOORS AND **EXTERNAL COOLING UNIT**



Dimensions

Length (mm) 1250 2000 2500 3750

AHT VENTO PREMIUM



Specifications

- Temperature Range: -1/ +3 C
- Cooling: Ventilated
- Ideal for Meat, Deli, Dairy, Drinks and Vegetables
- Depth: 73, 90, 100 and 110 cm
- Height: 205 cm or 220 cm as an Option
- Color: Black Interior and Exterior (or Any Color of Choice)
- Stainless Steel Case
- Stainless Steel Evaporator Base
- 2x Side Walls with Mirror, and Special Dark Gray Anti Scratch Paint
- Double Glass Doors with Anti-Fog System
- Doors With Blocker For The Period Of Loading
- Self-Closing Doors
- ECO FREE BLACK Doors
- LED Lighting on the Upper Part and on Each Door for Perfect Visibility
- LED 4500 or 6500K
- 4 Shelves of 45 cm on Each Row (plus base) with Glass Front Riser and Ticket Strip
- Professional Controller Dixell XR60CH
- Electrical Resistance For Automatic Defrosting
- Electrical Panel Included
- Thermostatic Valve Included
- Solenoid Valve Included

Optional

- Interior Entirely Made of Stainless Steel as an Option
- Full Glass Doors (without frame) as an Option
- LED Lighting for Deli and Meat as an Option
- Electrical Resistance For Condensation Water Evaporation as an Option
- Lighting Under Each Shelf as an Option
- Bar for Hooks as an Option
- Hooks for Deli or Meat as an Option
- Shelves: 50 cm and 60 cm as an Option
- PlexiGlass Divider as an Option
- Glass Side Walls as an Option

DISPLAY COOLER FOR SUPERMARKET WITH AIR CURTAIN OR DOORS AND **INTERNAL COOLING UNIT**



Dimensions

Length (mm) 1250 2000 2500 3750

AHT VENTO PREMIUM



Specifications

- Temperature Range: -1/ +3 C
- Cooling: Ventilated
- Ideal for Meat, Deli, Dairy, Drinks and Vegetables
- Depth: 90 and 100 cm
- Height: 205 cm or 220 cm as an Option
- Color: Black Interior and Exterior (or Any Color of Choice)
- Stainless Steel Case
- Stainless Steel Evaporator Base
- 2x Side Walls with Mirror, and Special Dark Gray Anti Scratch Paint
- Double Glass Doors with Anti-Fog System
- Doors With Blocker For The Period Of Loading
- Self-Closing Doors
- ECO FREE BLACK Doors
- LED Lighting on the Upper Part and on Each Door for Perfect Visibility
- LED 4500 or 6500K
- 4 Shelves of 45 cm on Each Row (plus base) with Glass Front Riser and Ticket Strip
- Professional Controller Dixell XR60CH
- Electrical Resistance For Automatic Defrosting

Optional

- Interior Entirely Made of Stainless Steel as an Option
- Full Glass Doors (without frame) as an Option
- LED Lighting for Deli and Meat as an Option
- Electrical Resistance For Condensation Water Evaporation as an Option
- Lighting Under Each Shelf as an Option
- Bar for Hooks as an Option
- Hooks for Deli or Meat as an Option
- Shelves: 50 cm and 60 cm as an Option
- PlexiGlass Divider as an Option
- Glass Side Walls as an Option

DISPLAY FREEZER FOR SUPERMARKET WITH **INTERNAL** OR **EXTERNAL** COOLING UNIT



Dimensions

Length (mm) 1564 2344 3124 3925
*or any dimension with multiplexing

AHT HMOP PREMIUM



Specifications

- Temperature Range: -18 / -24 C
- Cooling: Ventilated
- Exterior depth 90 or 100 cm
- Height: 205 cm or 220 cm as an OPTION
- Color: Light Gray Interior, Antracit Gray Exterior (or any other color)
- 2x Glass Side Walls
- Doors With Triple Glass And Anti-Fog System
- Doors With Blocker For The Period Of Loading
- ECO FREE BLACK Self-closing Glass Doors
- White LED Lighting On Each Door For Perfect Visibility
- LED 6500K Or 4500K
- 5 Shelves Of 40 Or 55 Cm On Each Row (plus base shelf)
- Shelves with Front Riser and Ticket Strip
- Professional Controller Dixell XR60CH
- Electrical Resistance For Automatic Defrosting
- Electrical Resistance For Condensation Water Evaporation
- Electrical Panel Included
- Thermostatic Valve Included
- Solenoid Valve Included

Optional

- Extra Shelves As An Option
- Plexiglass Separator Between Shelves As An Option
- Electric Resistance For Condensation Water Evaporation As An Option

DISPLAY FREEZER FOR SUPERMARKET WITH INTERNAL COOLING UNIT

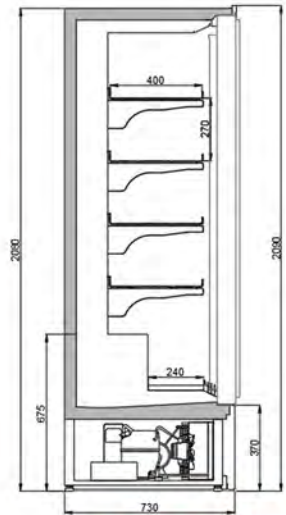

Dimensions

Length (mm) 1350 2000 2600

*or any dimension with multiplexing

PALERMO PREMIUM

Specifications

- Temperature Range: -18 / -24 C
- Cooling: Ventilated
- External depth 74 or 89 cm
- Height: 205 cm or 220 cm as an OPTION
- Color: Light Gray Interior, Antracit Gray Exterior (or any other color)
- 2x End Walls With Polyurethane Insulation And Anti Scratch Paint
- Doors With Triple Glass And Anti-Fog System
- Doors With Blocker For The Period Of Loading
- ECO FREE BLACK Self-closing Glass Doors
- White LED Lighting On Each Door For Perfect Visibility
- LED 6500K Or 4500K
- 4 Shelves Of 40 Or 55 Cm On Each Row (plus base shelf)
- Shelves With Front Riser and Ticket Strip
- Professional Controller Dixell XR60CH
- Electrical Resistance For Automatic Defrosting
- Electrical Resistance For Condensation Water Evaporation
- Electric Panel Included
- Thermostatic Valve Included
- Solenoid Valve Included

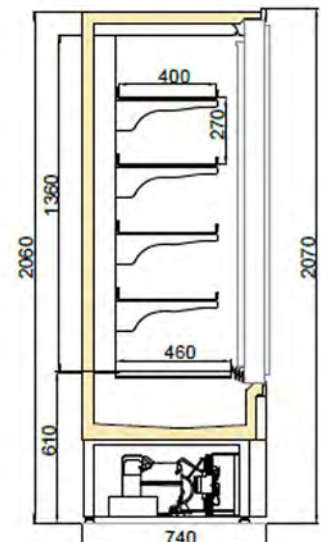
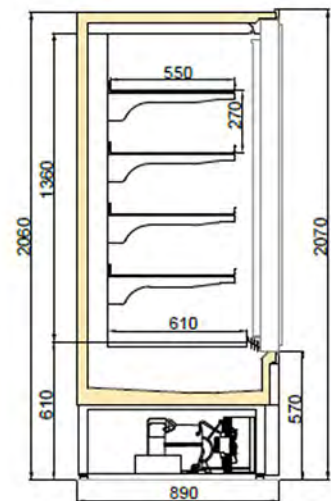

SUPERMARKET
COOLERS
AND FREEZERS

Optional

- Extra Shelves As An Option
- Plexiglass Separator Between Shelves As An Option
- Electrical Resistance For Condensation Water Evaporation As An Opt.

DISPLAY FREEZER FOR SUPERMARKET WITH **EXTERNAL** COOLING UNIT



Dimensions

Length (mm) 1650 2440 3220 4000

*or any dimension with multiplexing

PALERMO PREMIUM REMOTE



Specifications

Temperature Range: -18 / -24 C

Cooling: Ventilated

External depth 74 or 89 cm

Height: 205 cm or 220 cm as an OPTION

Color: Light Gray Interior, Antracit Gray Exterior (or any other color)

2x Side Walls With Polyurethane Insulation And Anti Scratch Paint

Doors With Triple Glass And Anti-Fog System

Doors With Blocker For The Period Of Loading

ECO FREE BLACK Self-closing Glass Doors

White LED Lighting On Each Door For Perfect Visibility

LED 6500K Or 4500K

5 Shelves Of 40 Or 55 Cm On Each Row (plus base shelf)

Shelves with Front Riser and Ticket Strip

Professional Controller Dixell XR60CH

Electrical Resistance For Automatic Defrosting

Electrical Resistance For Condensation Water Evaporation

Electric Panel Included

Thermostatic Valve Included

Solenoid Valve Included

SUPERMARKET
COOLERS
AND FREEZERS

Optional

Extra Shelves As An Option

Plexiglass Separator Between Shelves As An Option

Electrical Resistance For Condensation Water Evaporation As An Option

DISPLAY FREEZER FOR SUPERMARKET WITH EXTERNAL COOLING UNIT

TECHNICAL DRAWING FOR PALERMO PREMIUM

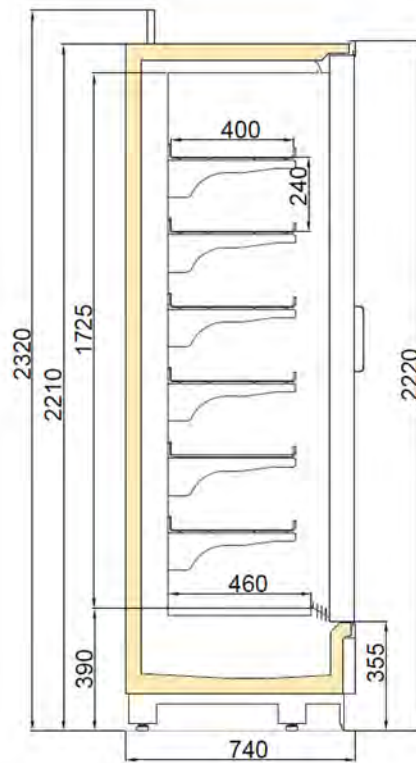
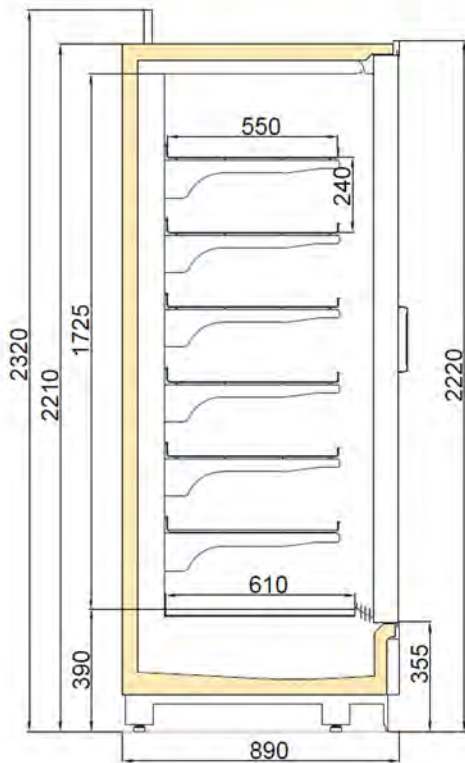
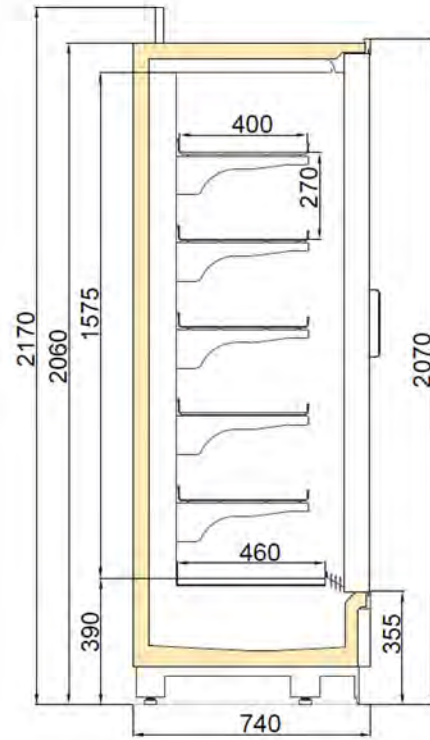
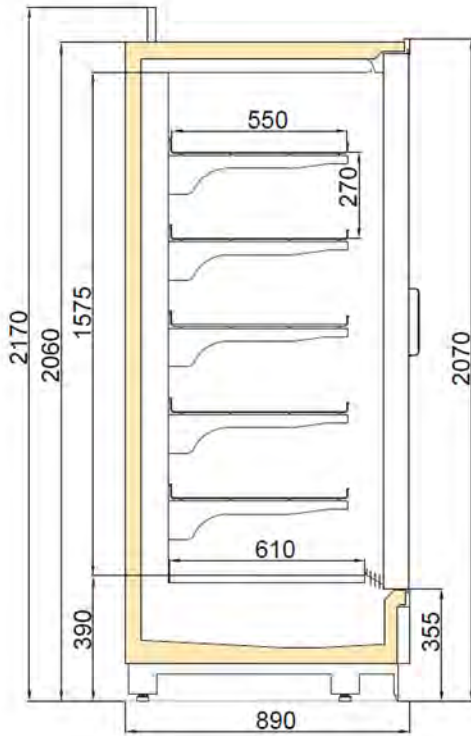

SUPERMARKET
COOLERS
AND FREEZERS

COLD AND FREEZER ROOMS

ON OUR WEBSITE: WWW.PETERSCOOLING.COM

COMPLETE COLD ROOMS
WITH **INTERNAL** OR **EXTERNAL** COOLING UNIT



COLD ROOMS

Dimensions

Any Size of Choice



COLD AND FREEZER ROOMS

Specifications

- Temperature Range: -2/ +8 C
- Cooling: Ventilated
- Hinged or Sliding Door
- Cooling Unit Included
- Fan Included
- Controller Included
- INOX Floor
- Anti-Slip Floor
- Digital Controller Dixell XR60CH
- Automatic Defrosting with Electrical Resistance
- LED Lighting
- Easy Assembly (modular)
- Stainless Steel Shelves Available as Accessory
- Stainless Steel Ramp Available as Accessory
- Flat or Ribbed Panel
- Panel Thickness: 80, 100, 120, 150, 200 mm
- Door Sensors
- Lock Included
- Silicon Curtain Included



COMPLETE FREEZER ROOMS
WITH **INTERNAL** OR **EXTERNAL** COOLING UNIT



FREEZER ROOMS

Dimensions

Any Size of Choice



Specifications

- Temperature Range: -18 / -24 C
- Cooling: Ventilated
- Hinged or Sliding Door
- Cooling Unit Included
- Fan Included
- Controller Included
- Stainless Steel Floor
- Anti-Slip Floor
- Digital Controller Dixell XR60CH
- Automatic Defrosting with Electrical Resistance
- LED Lighting
- Easy Assembly (modular)
- Stainless Steel Shelves Available as Accessory
- Stainless Steel Ramp Available as Accessory
- Flat or Ribbed Panel
- Panel Thickness: 120, 150, 200 mm
- Door Sensors
- Lock Included
- Silicon Curtain Included



COLD AND
FREEZER ROOMS



HOSPITALITY INDUSTRY EQUIPMENTS

ON OUR WEBSITE: WWW.PETERSCOOLING.COM

UPRIGHT STORAGE COOLER WITH INTERNAL COOLING UNIT



FS200-400-550-600 STORAGE



Dimensions

- FS200STORAGE - Exterior 600 x 585 x 855 mm, Interior 510 x 485 x 620 mm
- FS400STORAGE - Exterior 600 x 585 x 1855 mm, Interior 506 x 485 x 1620 mm
- FS550STORAGE - Exterior 770 x 722 x 1702 mm, Interior 600 x 555 x 1469 mm
- FS600STORAGE - Exterior 777 x 695 x 1895 mm, Interior 653 x 580 x 1680 mm

Specifications

- Temperature Range: +2/+8 C
- Ambient Temperature: +16 / +25 C
- Cooling: Ventilated
- Hinged Door
- 2 Fixed Feet
- 2 Castors
- Digital Controller Dixell with Blue LED
- Automatic Defrost
- Digital Thermometer
- Stainless Steel Exterior
- ABS White Interior
- Shelves Included GN 2/1
- Adjustable Feet
- Lock Included

Volume:

- FS200STORAGE - 130 liters
- FS400STORAGE - 374 liters
- FS550STORAGE - 461 liters
- FS600STORAGE - 605 liters



HOSPITALITY INDUSTRY
EQUIPMENTS

UPRIGHT STORAGE FREEZER WITH INTERNAL COOLING UNIT



Dimensions

FS200FSTORAGE - Exterior 600 x 600 x 850 mm, Interior 484 x 470 x 610 mm

FS400FSTORAGE - Exterior 600 x 585 x 1855 mm, Interior 484 x 470 x 1620 mm

FS600FSTORAGE - Exterior 777 x 695 x 1895 mm, Interior 653 x 580 x 1680 mm

Specifications

Temperature Range: -10 / -24 C

Ambient Temperature: +16 / +25 C

Cooling: Ventilated

Hinged Door

2 Fixed Feet

2 Castors

Digital Controller Dixell with Blue LED

Automatic Defrost

Digital Thermometer

Stainless Steel Exterior

ABS White Interior

Shelves Included GN 2/1

Adjustable Feet

Lock Included

Volume:

FS200STORAGE - 130 liters

FS400STORAGE - 374 liters

FS600STORAGE - 605 liters



HOSPITALITY INDUSTRY
EQUIPMENTS

PROFESSIONAL UPRIGHT STORAGE COOLER WITH INTERNAL COOLING UNIT

FS505F STORAGE



FS1420F STORAGE



FS1010F STORAGE



Dimensions

FS505FSTORAGE - Exterior 680 x 700 x 2010 mm, Interior 560 x 553 x 1386 mm

FS1010FSTORAGE - Exterior 1340 x 700 x 2010 mm, Interior 1220 x 553 x 1386 mm

FS1420FSTORAGE - Exterior 1480 x 850 x 2010 mm, Interior 1360 x 685 x 1396 mm

Specifications

- Temperature Range: -2/ +10 C
- Ambient Temperature: +16/ +25 C
- Cooling: Ventilated
- Hinged Door
- Self-Closing Door
- 4 Castors
- Digital Controller Dixell with Blue LED
- Automatic Defrost
- Digital Thermometer
- Stainless Steel Exterior
- Stainless Steel Interior
- Shelves Included GN 2/1
- Adjustable Feet
- Lock Included

Volume:

- FS505STORAGE - 466 liters
- FS1010STORAGE - 976 liters
- FS1420STORAGE - 1410 liters



HOSPITALITY INDUSTRY
EQUIPMENTS

PROFESSIONAL UPRIGHT STORAGE FREEZER WITH INTERNAL COOLING UNIT

FS505FF STORAGE



FS1420FF STORAGE



FS1010FF STORAGE



Dimensions

FS505FFSTORAGE - Exterior 680 x 700 x 2010 mm, Interior 560 x 553 x 1386 mm

FS1010FFSTORAGE - Exterior 1340 x 700 x 2010 mm, Interior 1220 x 553 x 1386 mm

FS1420FFSTORAGE - Exterior 1480 x 850 x 2010 mm, Interior 1360 x 685 x 1396 mm

Specifications

- Temperature Range: -18 / -24 C
- Ambient Temperature: +16 / +25 C
- Cooling: Ventilated
- Hinged Door
- Self-Closing Door
- 4 Castors
- Digital Controller Dixell with Blue LED
- Automatic Defrost
- Digital Thermometer
- Exterior, Interior: Stainless Steel
- Shelves Included GN 2/1
- Adjustable Feet
- Lock Included

Volume:

FS505STORAGE - 466 liters

FS1010STORAGE - 976 liters

FS1420STORAGE - 1410 liters



PROFESSIONAL UPRIGHT STORAGE COOLER WITH GLASS WITH INTERNAL COOLING UNIT



FS710G, FS1420G - STORAGE



Dimensions

FS710GSTORAGE - Exterior 740 x 850 x 2010 mm, Interior 624 x 685 x 1396 mm

FS1420GSTORAGE - Exterior 1480 x 850 x 2010 mm, Interior 1360 x 685 x 1396 mm

Specifications

Temperature Range: -2/ +10 C
Ambient Temperature: +16/ +45 C
Cooling: Ventilated
Hinged Glass Door
Self-Closing Door
4 Castors
Digital Controller Dixell with Blue LED
Automatic Defrost
Digital Thermometer
Exterior: Stainless Steel
Interior: Stainless Steel
Shelves Included GN 2/1
Adjustable Feet
Lock Included

Volume:

FS710GSTORAGE - 650 liters

FS1420GSTORAGE - 1410 liters



WASTE BIN COOLER



65 X 76 X 110 CM



174 X 99 X 128 CM



Specifications

- Temperature Range: -2 / +10 C
- Ambient Temperature: +16 / +45 C
- Cooling: Ventilated
- Hinged Door
- Self-Closing Door
- Fixed INOX Feet
- Digital Controller Dixell with Blue LED
- Automatic Defrost
- Digital Thermometer
- Exterior: Stainless Steel
- Interior: Stainless Steel
- Suitable for 120 L or 140 L Waste Bins
- Adjustable Feet

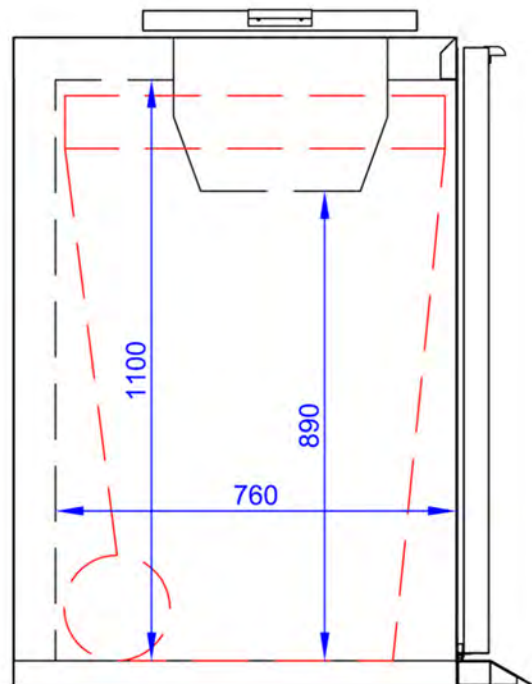

PROFESSIONAL ICE MAKER



Dimensions

39 x 52 x 64 cm: 26 kg per day, 8 kg storage capacity

55 x 58 x 69 cm: 37 kg per day, 16 kg storage capacity

74 x 60 x 83 cm: 85 kg per day, 40 kg storage capacity



Specifications

Cubed Ice Approx.: 31x35x31 mm (18g)

Stainless Steel Interior and Exterior

Adjustable Feet

Digital Controller

Low Energy Consumption

Antimicrobial Technology

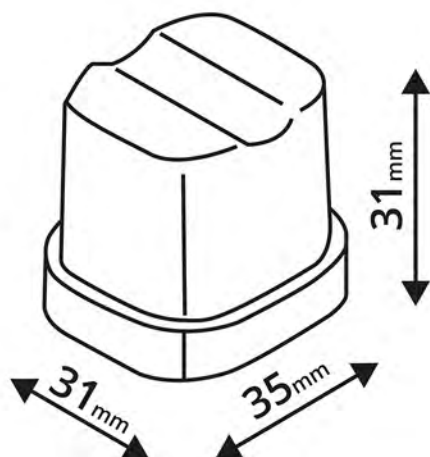

PROFESSIONAL COUNTER COOLERS

WITH HINGED DOORS, STAINLESS STEEL INTERIOR / EXTERIOR AND INTERNAL COOLING UNIT



FS7210STORAGE

FS7310STORAGE

FS7410STORAGE



Dimensions

FS7210STORAGE - Exterior 1360 x 700 x 980 mm, Interior 902 x 530 x 589 mm

FS7310STORAGE - Exterior 1795 x 700 x 980 mm, Interior 1337 x 530 x 589 mm

FS7410STORAGE - Exterior 2230 x 700 x 980 mm, Interior 1772 x 530 x 589 mm

Specifications

Temperature Range: -2 / +10 C

Ambient Temperature: +16 / +45 C

Cooling: Ventilated

Hinged Door

Self-Closing Door

Fixed Stainless Steel Feet

Digital Controller Dixell with Blue LED

Automatic Defrost

Digital Thermometer

Exterior: Stainless Steel

Interior: Stainless Steel

Shelves Included GN 1/1

Adjustable Feet

Volume:

FS7210STORAGE - 282 liters

FS7310STORAGE - 417 liters

FS7410STORAGE - 553 liters



HOSPITALITY INDUSTRY
EQUIPMENTS

PROFESSIONAL COUNTER FREEZER

WITH HINGED DOORS, STAINLESS STEEL INTERIOR / EXTERIOR AND INTERNAL COOLING UNIT



FS7210FSTORAGE

FS7310FSTORAGE

FS7410FSTORAGE



Dimensions

FS7210FSTORAGE - Exterior 1360 x 700 x 980 mm, Interior 902 x 530 x 589 mm

FS7310FSTORAGE - Exterior 1795 x 700 x 980 mm, Interior 1337 x 530 x 589 mm

FS7410FSTORAGE - Exterior 2230 x 700 x 980 mm, Interior 1772 x 530 x 589 mm

Specifications

- Temperature Range: -10 / -20 C
- Ambient Temperature: +16 / +35 C
- Cooling: Ventilated
- Hinged Door
- Self-Closing Door
- Fixed Stainless Steel Feet
- Digital Controller Dixell with Blue LED
- Automatic Defrost
- Digital Thermometer
- Stainless Steel Exterior
- Stainless Steel Interior
- Shelves Included GN 1/1
- Adjustable Feet

Volume:

- FS7210FSTORAGE - 282 liters
- FS7310FSTORAGE - 417 liters
- FS7410FSTORAGE - 553 liters



PROFESSIONAL REFRIGERATED PIZZA COUNTER

WITH HINGED DOORS, STAINLESS STEEL INTERIOR / EXTERIOR AND INTERNAL COOLING UNIT



FS920PIZZA



FS930PIZZA



Dimensions

FS920PIZZA - Exterior 900 x 700 x 1100 mm, Interior 830 x 515 x 526 mm

FS930PIZZA - Exterior 1365 x 700 x 1100 mm, Interior 1295 x 515 x 500 mm

Specifications

- Temperature Range: -2 / +6 C
- Ambient Temperature: +16 / +35 C
- Cooling: Ventilated
- Hinged Doors
- Self-Closing Doors
- Granite Table Top
- Cooled Pans
- Digital Controller Dixell with Blue LED
- Automatic Defrost
- Digital Thermometer
- Stainless Steel Exterior
- Stainless Steel Interior
- GN 1/6 for Pans
- Adjustable Feet

Volume:

FS920PIZZA - 260 liters

FS930PIZZA - 400 liters



HOSPITALITY INDUSTRY
EQUIPMENTS

COUNTER COOLER WITH DRAWERS

STAINLESS STEEL INTERIOR / EXTERIOR AND INTERNAL COOLING UNIT



FS7240, 4 DRAWERS



FS7360, 6 DRAWERS

Dimensions

FS7240, 4 drawers - Exterior 1360 x 700 x 980 mm, Interior 902 x 530 x 589 mm

FS7360, 6 drawers - Exterior 1795 x 700 x 980 mm, Interior 1337 x 530 x 589 mm

Specifications

Temperature Range: +2 / +10 C
Ambient Temperature: +16 / +35 C
Cooling: Ventilated
Cooled Drawers
Digital Controller Dixell with Blue LED
Automatic Defrost
Digital Thermometer
Stainless Steel Exterior
Stainless Steel Interior
Adjustable Feet

Volume:

FS7240 - 282 liters

FS7360 - 417 liters



HOSPITALITY INDUSTRY
EQUIPMENTS

COUNTER COOLER WITH HINGED DOORS AND DRAWERS

STAINLESS STEEL INTERIOR / EXTERIOR AND INTERNAL COOLING UNIT



FS1310



Dimensions

FS1310 - Exterior 2045 x 800 x 1000 mm, Interior 1052 x 630 x 589 mm

Specifications

- Temperature Range: +2 / +10 C
- Ambient Temperature: +16 / +35 C
- Cooling: Ventilated
- Hinged Doors
- Cooled Drawers
- Digital Controller Dixell with Blue LED
- Automatic Defrost
- Digital Thermometer
- Stainless Steel Exterior
- Stainless Steel Interior
- Adjustable Feet

Volume:
FS1310 - 390 liters



HOSPITALITY INDUSTRY
EQUIPMENTS

REFRIGERATED COUNTER FOR FAST FOOD WITH TOPPING UNIT

WITH HINGED DOORS, STAINLESS INTERIOR / EXTERIOR AND INTERNAL COOLING UNIT



FS1200PIZZA



FS1300PIZZA



Dimensions

FS920PIZZA - Exterior 900 x 700 x 1100 mm, Interior 830 x 515 x 526 mm

FS930PIZZA - Exterior 1365 x 700 x 1100 mm, Interior 1295 x 515 x 500 mm

Specifications

- Temperature Range: +2 / +10 C
- Ambient Temperature: +16 / +35 C
- Cooling: Ventilated
- Hinged Door
- Self-Closing Door
- Granite Table Top
- Cooled Display Unit for Ingredients
- Digital Controller Dixell with Blue LED
- Automatic Defrost
- Digital Thermometer
- Stainless Steel Exterior
- Stainless Steel Interior
- GN 1/6 for Display Unit for Ingredients
- Adjustable Feet

Volume:

FS1200PIZZA - 390 liters

FS1300PIZZA - 580 liters



PROFESSIONAL COUNTER COOLERS

WITH HINGED GLASS DOORS, STAINLESS STEEL INTERIOR / EXTERIOR AND INTERNAL COOLING UNIT



FS7210G STORAGE

FS7310G STORAGE

FS7410G STORAGE



Dimensions

FS7210GSTORAGE - Exterior 1360 x 700 x 980 mm, Interior 902 x 530 x 589 mm

FS7310GSTORAGE - Exterior 1795 x 700 x 980 mm, Interior 1337 x 530 x 589 mm

FS7410GSTORAGE - Exterior 2230 x 700 x 980 mm, Interior 1772 x 530 x 589 mm

Specifications

Temperature Range: -2 / +10 C
Ambient Temperature: +16 / +25 C
Cooling: Ventilated
Hinged Glass Doors
Self-Closing Doors
Fixed Stainless Steel Feet
Digital Controller Dixell with Blue LED
Automatic Defrost
Digital Thermometer
Stainless Steel Exterior
Stainless Steel Interior
Shelves Included GN 1/1
Adjustable Feet

Volume:

FS7210GSTORAGE - 282 liters

FS7310GSTORAGE - 417 liters

FS7410GSTORAGE - 553 liters



HOSPITALITY INDUSTRY
EQUIPMENTS



SUPERMARKET SHELVES

ON OUR WEBSITE: WWW.PETERSCOOLING.COM

METAL SUPERMARKET SHELVES

ISLAND SHELVES (GONDOLA)



Any Dimension is Available At Request

Dimensions

70x140, base 40 cm and shelves of 30 cm
100x140, base 40 cm and shelves of 30 cm
125x140, base 40 cm and shelves of 30 cm
70x140, base 50 cm and shelves of 40 cm
100x140, base 50 cm and shelves of 40 cm
125x140, base 50 cm and shelves of 40 cm
70x180, base 40 cm and shelves of 30 cm
100x180, base 40 cm and shelves of 30 cm
125x180, base 40 cm and shelves of 30 cm
70x180, base 50 cm and shelves of 40 cm
100x180, base 50 cm and shelves of 40 cm
125x180, base 50 cm and shelves of 40 cm

Specifications

Shelf Capacity: 100 kg
Base Capacity: 250 kg
Recommended to Arrange the Weight in a Pyramidal System
Color: Antracit Ral 7016
Shelves Equipped with Ticket Strips
Shelves Can Be Provided with Various Accessories

SUPERMARKET SHELVES

METAL SUPERMARKET SHELVES

ANTRACIT GRAY OR WHITE



Any Dimension is Available At Request

Dimensions

- 70x225, base 40 cm and shelves of 30 cm
- 100x225, base 40 cm and shelves of 30 cm
- 125x220, base 40 cm and shelves of 30 cm
- 70x225, base 50 cm and shelves of 40 cm
- 100x225, base 50 cm and shelves of 40 cm
- 125x220, base 50 cm and shelves of 40 cm

Specifications

- Shelf Capacity: 100 kg
- Base Capacity: 250 kg
- Recommended to Arrange the Weight in a Pyramidal System
- Color: Antracit Gray Ral 7016 or White Ral 9016
- Shelves Equipped with Ticket Strips and Front Riser
- Shelves Can Be Provided with Various Accessories

SUPERMARKET SHELVES

METAL SUPERMARKET SHELVES

ISLAND SHELVES (GONDOLA)



Any Dimension is Available At Request

Dimensions

- 60x140, base 40 cm and shelves of 30 cm
- 90x140, base 40 cm and shelves of 30 cm
- 70x180, base 40 cm and shelves of 30 cm
- 100x180, base 40 cm and shelves of 30 cm
- 70x180, base 50 cm and shelves of 40 cm
- 100x180, base 50 cm and shelves of 40 cm
- 70x140, base 40 cm and shelves of 30 cm
- 100x140, base 40 cm and shelves of 30 cm
- 70x140, base 50 cm and shelves of 40 cm
- 100x140, base 50 cm and shelves of 40 cm

Specifications

- Shelf Capacity: 100 kg
- Base Capacity: 250 kg
- Recommended to Arrange the Weight in a Pyramidal System
- Main Color: White (RAL 9016)
- Secondary Color: Red
- Optional Main Color: Silver Gray (RAL 7001); Gray (RAL 7046); Marine Blue (RAL 5002); Red (RAL 3020); Orange (RAL 2004); Turquoise (RAL 5018); Black (RAL 9005), Yellow (RAL1023); Yellowish Green (RAL 6018)
- Shelves Equipped with Ticket Strips
- Shelves Can Be Provided with Various Accessories on Request

SUPERMARKET SHELVES

METAL AND WOOD SHELF FOR PASTRY



Any Dimension is Available At Request

Dimensions

100x50x220 cm

Specifications

Shelf Capacity: 100 kg

Base Capacity: 250 kg

Recommended to Arrange the Weight in a Pyramidal System

Shelves Can Be Provided with Various Accessories on Request

VEGETABLE AND FRUIT STAND

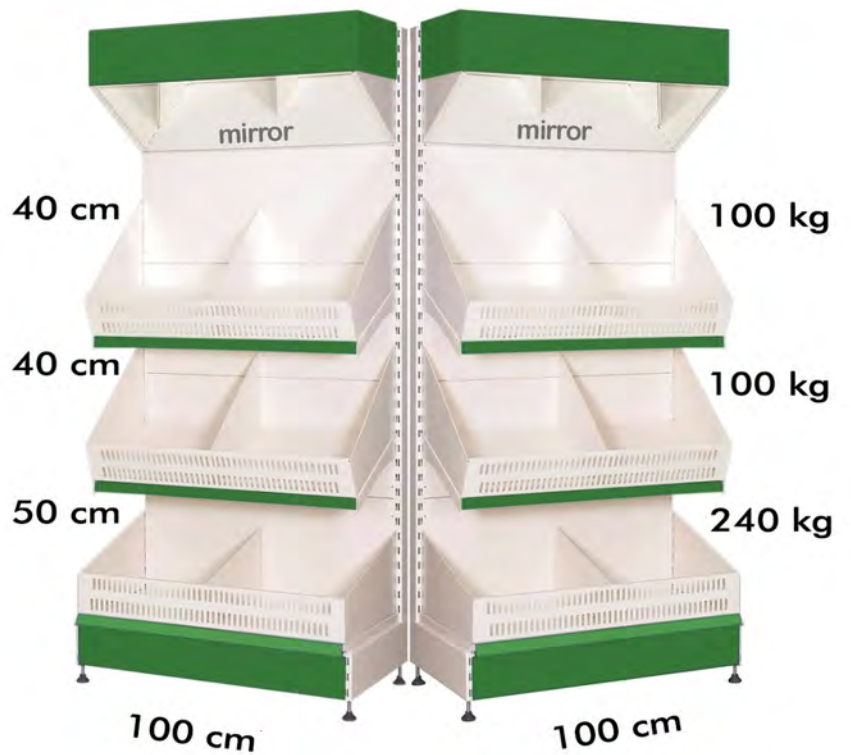

Any Dimension is Available At Request

Dimensions

126 x 77 x 159cm

Dimensions

70 x 50 x 220 cm

100 x 50 x 220 cm

125 x 50 x 220 cm

SUPERMARKET
SHELVES

Specifications

Shelf Capacity: 100 kg

Recommended to Arrange the Weight in a Pyramidal System

Shelves Can Be Provided with Various Accessories on Request

CONDENSING UNITS AND CENTRAL SYSTEMS

BITZER, TECUMSEH, DANFOSS OR EMBRACO



Any Dimension And Any Cooling Capacity is Available At Request

R404 / R448 / R449 / R452 / R134

Equipped with:

Case, Insulation, Compressor, Liquid Tank, Fan, Electrical Panel, Phase Monitoring

Dual Pressure Switch, Fan Pressure Switch, Liquid Sight Glass, Filter, Digital Controller

Cooling

- M030 - cooling capacity at -10 / +45: 2.62 kW
- M055 - cooling capacity at -10 / +45: 3.98 kW
- M070 - cooling capacity at -10 / +45: 4.67 kW
- M080 - cooling capacity at -10 / +45: 5.33 kW
- M100 - cooling capacity at -10 / +45: 6.25 kW
- M150 - cooling capacity at -10 / +45: 8.91 kW
- M160 - cooling capacity at -10 / +45: 10.46 kW
- M180 - cooling capacity at -10 / +45: 12.29 kW
- M220 - cooling capacity at -10 / +45: 15.70 kW
- M270 - cooling capacity at -10 / +45: 18.49 kW
- M300 - cooling capacity at -10 / +45: 20.30 kW

Freezing

- L013 - cooling capacity at -25 / +45: 1.49 kW
- L024 - cooling capacity at -25 / +45: 2.42 kW
- L032 - cooling capacity at -25 / +45: 2.99 kW
- L040 - cooling capacity at -25 / +45: 3.58 kW
- L055 - cooling capacity at -25 / +45: 4.56 kW
- L085 - cooling capacity at -25 / +45: 7.05 kW
- L100 - cooling capacity at -25 / +45: 9.71 kW



HOSPITALITY INDUSTRY EQUIPMENTS

SUPERMARKET EQUIPMENTS

METAL SHELVES FOR STORAGE

COOLING UNITS WITH HOUSING

COOLING UNITS WITHOUT HOUSING

REFRIGERATION COMPRESSORS

REFRIGERATOR ACCESSORIES



WWW.PETERSCOOLING.COM

FACEBOOK, TIKTOK: PETERS COOLING

© PETER'S COOLING 2023